

**Synapse**  
Energy Economics, Inc.

# **Water Constraints on Energy Production:**

**Altering our Current Collision Course**

**Prepared for the Civil Society Institute**

**September 12, 2013**

**AUTHORS**

**Melissa Whited, Frank Ackerman, & Sarah Jackson**



485 Massachusetts Ave.  
Suite 2  
Cambridge, MA 02139

617.661.3248  
[www.synapse-energy.com](http://www.synapse-energy.com)



# Table of Contents

<b>FOREWORD</b> .....	<b>I</b>
<b>EXECUTIVE SUMMARY</b> .....	<b>III</b>
A. WATER QUANTITY CONSTRAINTS.....	III
B. ENERGY'S IMPACTS ON WATER QUALITY.....	V
C. THE INFORMATION GAP: DATA NEEDS FOR SUSTAINABLE ENERGY PLANNING .....	VII
D. RECOMMENDATIONS .....	VIII
<b>1. INTRODUCTION</b> .....	<b>1</b>
<b>2. ENERGY PRODUCTION IN A WATER-CONSTRAINED WORLD</b> .....	<b>4</b>
A. KNOWN WATER QUANTITY CONSTRAINTS .....	5
<i>Limited Supplies and Growing Water Demands</i>	5
<i>Water for Energy: Thermoelectric Power</i>	7
<i>Water for Energy: Hydroelectricity</i>	17
<i>Vulnerabilities of Power Plants to Water Shortages</i>	17
B. UNKNOWN WATER QUANTITY CHALLENGES .....	19
<i>Intersectoral Conflicts and Legal Uncertainty</i>	19
<i>Future Regulatory Actions</i>	20
<i>Climate Change: The Known Unknown</i>	21
<b>3. ENERGY'S IMPACTS ON WATER QUALITY</b> .....	<b>24</b>
A. KNOWN WATER QUALITY CHALLENGES .....	24
<i>Coal Mining</i>	24
<i>Uranium Mining and Milling</i>	27
<i>Natural Gas Production</i>	29
<i>Power Plant Waste Disposal</i>	32
<i>Thermal Pollution from Once-Through Cooling</i>	35
B. UNKNOWN WATER QUALITY CHALLENGES .....	37
<i>Climate Change and Water Quality</i>	37
<i>Health Impacts of Hydraulic Fracturing</i>	38
<b>4. THE INFORMATION GAP: DATA NEEDS FOR SUSTAINABLE ENERGY PLANNING</b> .....	<b>39</b>

A.	INADEQUATE POWER PLANT DATA COLLECTION AND INACCURATE REPORTING .....	39
B.	UNCERTAINTY ASSOCIATED WITH CLIMATE CHANGE IMPACTS .....	40
C.	GROUNDWATER UNKNOWNNS .....	41
D.	WATER RIGHTS UNCERTAINTY .....	41
E.	INADEQUATE REPORTING OF CHEMICALS USED IN FRACKING.....	42
F.	INSUFFICIENT DATA AND MONITORING OF FGD WASTEWATER TREATMENT EFFECTIVENESS	42
<b>5.</b>	<b>CASE STUDIES .....</b>	<b>43</b>
A.	OHIO.....	43
	<i>Risky Developments in Natural Gas</i> .....	44
	<i>Coal Mining in Ohio</i> .....	45
	<i>Climate Change Impacts in a "Wet" State</i> .....	46
B.	COLORADO.....	47
	<i>Mining in Colorado</i> .....	48
	<i>Electricity Generation in Colorado</i> .....	51
	<i>Climate Change in the Southwest</i> .....	53
	<i>Energy-Water Management Initiatives in Colorado</i> .....	54
<b>6.</b>	<b>SUMMARY AND RECOMMENDATIONS.....</b>	<b>55</b>
<b>7.</b>	<b>WORKS CITED .....</b>	<b>59</b>
<b>8.</b>	<b>APPENDIX .....</b>	<b>71</b>
A.	WATER CONSUMPTION FOR CARBON CAPTURE.....	71

## Foreword

“Water Constraints on Energy Production” is the 6<sup>th</sup> in a series of reports conducted by Synapse Energy Economics for the Civil Society Institute. The report points to the many unanswered questions and the urgency of a thorough understanding about water consumption and use by the electric sector and the challenges to it in a water constrained world.

In 2005, the U.S. Senate Committee on Energy and Natural Resources mandated the Department of Energy to produce an Energy/Water Roadmap of the energy sector’s water needs and the impacts on the environment, agriculture, and other residential and commercial uses.

After years of bureaucratic infighting and an apparent desire by DOE government employees to avoid controversy for the Federal government, a diluted report was sent to the White House and the Office of Management and Budget. That report, as watered down as the final draft was, has yet to be released to the Congress and the public eight years after the Senate mandate.

During that time, there has been an explosion of water-intensive energy development by the oil and gas industry. We have had severe regional droughts. Intensive heat waves have warmed the waters necessary for cooling existing power plants. In testimony before Congress, a representative of the NOAA stated, “The 2007-2009 severe drought in the Southeast threatened the cooling water supplies of more than 24 of the nation’s 104 nuclear power reactors” ... and... “a severe drought in Texas in 2011 affected many power plants’ cooling water reservoirs....”<sup>1</sup> In August of 2012 for the first time ever, Unit 2 of the Millstone nuclear power station in Connecticut had to be shut down because the water from Long Island Sound was too warm to cool the reactor.

Diminishing fresh water aquifers, drought, and competing agricultural demands present an urgent need for the Federal government to take the lead in identifying what water resources we have and how best to use and protect those resources. Vital water data has yet to be gathered by agencies of the government. The United States Geological Survey (USGS) has not been funded adequately to gather this information. We do not have a thorough understanding of groundwater resources and the interconnection of aquifers and yet we continue to drill shale gas wells and frack them without this essential information.

**The U.S. is spending a water budget without understanding how much water is available or what the use of water in energy production will mean for local communities, agriculture, or other commercial uses.**

---

<sup>1</sup> National Oceanic and Atmospheric Administration, U.S. Department of Commerce, Testimony before the Committee on Energy and Natural Resources, U.S. Senate; *Drought and the Effect on Energy and Water Management Decisions*, testimony of Dr. Roger S. Pulwarty, Director, National Integrated Drought Information System, April 25, 2013, [http://www.energy.senate.gov/public/index.cfm/files/serve?File\\_id=553f571e-f44a-466d-89ef-16a6ccbab7b0](http://www.energy.senate.gov/public/index.cfm/files/serve?File_id=553f571e-f44a-466d-89ef-16a6ccbab7b0), p.5.

There are energy sources available to us that are not water intensive. They have the added benefits of preserving water and protecting drinking water from harmful chemicals and producing energy from sources that cannot be exhausted over time. Wind and solar power are mature technologies and numerous studies have demonstrated that our energy needs can be met with these technologies combined with increasing energy efficiency and storage technologies.

A safe, renewable energy future has been deferred by politics not by technological innovation, though many innovations are around the corner. The enormous economic and political influence of the electric utility companies and the oil, gas, coal and nuclear industries presents one of the major challenges of moving toward a new energy path.

It is argued that the Federal government should not pick winners and losers and that the market should determine what energy sources power our lives and our future. Yet, none of the conventional energy sources would exist or continue logging record profits if not for the favorable treatment by the Federal government through tax incentives, tax breaks, and direct loans and loan guarantees. In many cases, regional commissions provide water withdrawal permits for drilling and mining without the necessary data on the water/energy tradeoffs and impacts.

Wind and solar energy have also lined up for government support and it is right to claim that they too would not be making gains without public investment. The difference is that the investment in the latter produces public benefit; the fuel sources are plentiful and, over time, will produce the least cost energy for our country.

It is time to be decisive, to choose an energy path that is sustainable and that protects public health. A hard-headed analysis of our water resources and how to manage them in the context of energy choices should be our roadmap.

Pam Solo  
President  
Civil Society Institute

## Executive Summary

Today's electric power system was built on traditional, water-intensive thermoelectric and hydroelectric generators. The water requirements of this energy system are enormous. Large fossil fuel and nuclear power plants with once-through cooling systems withdraw staggeringly large quantities of water from rivers, lakes, and estuaries; plants with recirculating cooling systems withdraw less water, but actually *consume* more via evaporation.

Water supply issues are already forcing thermoelectric power plants in some regions to shut down under dry and hot conditions—a problem that will only worsen as populations grow and climate change increases the frequency and duration of droughts and heat waves. The repercussions of forced shut-downs include reliability impacts and higher electric rates linked to costly replacement power purchases and investments in water-supply infrastructure.

At the same time, power plant operations and production of fuels for electricity generation carry serious risks for water quality. Energy impacts on water include pollution risks from fracking in gas-producing states, fish kills, thermal pollution, polluted effluent, and coal ash spills at power plants. The need to address water quality impacts will become even more urgent if domestic fracking for shale gas grows at the rate anticipated by the U.S. Energy Information Administration (EIA).

This study undertakes a comprehensive review of the many water-related problems and constraints related to the electricity sector. The issues we address include:

- Water supply shortages, especially in the West, where major river systems are overstressed, groundwater aquifers are being depleted, and agriculture is dependent on water for irrigation
- Water demand crises, even in naturally wet regions such as the Southeast, where rapid population growth and traditional, inefficient patterns of water use, such as once-through power plant cooling, have strained the available supplies
- Upstream impacts of fossil-fuel production, such as the water pollution hazards created by coal mining and by fracking in the oil and gas industry
- Hydropower production losses caused by reduced or more volatile flows in major rivers
- Impacts of power plant operation on water quality, including impacts on fish and other aquatic life by cooling water intakes, thermal impacts of heated water discharge, and pollution from power plant effluent
- Waste disposal risks, such as water pollution and ash spill risks from coal ash disposal

The key findings and recommendations of this study are presented below.

### A. Water Quantity Constraints

The amount of water available to serve diverse needs is a growing concern across the country, from the arid western states to the seemingly water-rich Southeast. Currently, 97 percent of the nation's electricity comes from thermoelectric or hydroelectric generators, which rely on vast quantities of water to produce electricity.

Thermoelectric plants are major water users; they withdraw 41 percent of the nation's fresh water—more than any other sector. On an average day, water withdrawals across the nation amount to an estimated 85 billion gallons for coal plants, 45 billion gallons for nuclear plants, and 7 billion gallons for natural gas plants. Significant amounts of water are also required for fossil fuel extraction, refining and processing, and transportation. Coal mining consumes between 70 million and 260 million gallons of water per day, and natural gas fracking requires between 2 and 6 million gallons of water per well for injection purposes.

In contrast, many renewable resources such as wind and solar photovoltaics (PV) require little to no water.

The EIA projects that use of thermoelectric power plants will continue to increase to meet the electricity needs of a U.S. population expected to grow by another 100 million by 2060. If current trends continue, water supplies will simply be unable to keep up with our growing demands. Factors that are likely to exacerbate this problem include the following:

- **Carbon capture and sequestration (CCS):** The wholesale conversion of coal and natural gas plants to CCS would result in dramatic increases in the amounts of water withdrawn and consumed by thermoelectric plants in the United States. Though not yet common, CCS may become widely adopted to comply with new environmental regulations. CCS increases the water usage of coal and natural gas-fired power plants substantially, increasing consumption rates by 83 percent for existing coal plants, or by 58 percent for new integrated gasification units. CCS is projected to nearly double natural gas water consumption rates, causing a 91 percent increase. As water resources become scarcer in many parts of the country, this may limit the ability of plants with CCS to operate, particularly during heat waves or droughts.
- **Climate change:** Climate models show unequivocal evidence that average temperatures worldwide are rising, and that water resources will be significantly impacted. Likely impacts on water resources for power production include:
  - Substantial shifts in where and how precipitation will occur, with certain regions, especially the Mountain West and Southwest, expected to become more arid and experience less runoff.
  - Precipitation will likely become less frequent but more intense, with heavy downpours increasing and greater precipitation falling in the form of rain as opposed to snow, thus decreasing mountain snowpack and runoff while making stream flows more intense and more variable.
  - Seasonal flows in rivers will become more erratic and experience shifts in timing of high and low flows, with likely reductions in flows during the summer months.
  - Hotter temperatures will increase electricity use due to higher air conditioning loads, while causing power plants to operate less efficiently and require more water for cooling.

Such impacts imply that when loads are highest—on hot summer days—less energy will be available from water-intensive hydroelectric and thermoelectric power plants.



- **Water shortages:** Declining availability of water resources (due to climate change or other causes) may threaten power generation reliability. Already, lack of sufficient water has constrained power production in numerous cases, particularly during times of drought. These situations have resulted in increased costs to consumers, both for high-cost replacement power, and for infrastructure projects intended to increase water supplies, such as a 17-mile pipeline for a coal plant in Wyoming.

Water shortages can also pit users in one sector against another, even when users hold formal water rights. Legal battles arise when water rights are ill-defined or over-allocated; these battles may extend for years, jeopardizing the timely construction of new generation capacity. In times of drought, thermoelectric generators may face even greater uncertainty regarding their water rights. The North American Electric Reliability Corporation estimates that electric generators totaling 9,000 MW capacity are “at risk of curtailment if their water rights are recalled to allow the available water to be used for other purposes.”

Failure to address these constraints now is bound to lead to further intersectoral conflicts and forced plant shutdowns that jeopardize electricity production and constrain economic growth.

## B. Energy’s Impacts on Water Quality

Electric-sector impacts on water quality are significant, and are likely to increase if the United States continues to rely heavily on thermoelectric power plants to meet energy needs. Many of the costs associated with these impacts are currently borne by the communities located near the resources, not by energy producers or consumers; this makes thermoelectric power appear to be much cheaper than it truly is.

Water quality impacts associated with fossil fuel and uranium production include the following:

**Coal mining:** Mining, transporting, processing, and burning of coal, along with coal ash disposal, are important causes of human and ecological harms. Elevated levels of arsenic and other heavy metals have been found in drinking water in coal mining areas, often exceeding safe drinking water standards. Coal mining has been associated with numerous human health problems. Studies discussed in this report have found strong correlations between coal mining and: total, cancer, and respiratory mortality rates; chronic cardiovascular disease mortality rates; higher levels of birth defects; and poor physical and mental health. In heavily mined areas, streams display less diverse populations of aquatic life, with the effects extending far downstream from the mining areas. These problems can persist for years; some mines reclaimed nearly 20 years earlier continue to degrade water quality. In Appalachia, more than 2,000 km of streams have been buried under mining overburden, devastating freshwater habitats in the region.

**Uranium mining and milling:** Since 1980, domestic production of uranium has sharply declined. However, recent increases in uranium prices have led to renewed interest in uranium mining in the United States, a scenario that calls for renewed concern about water quality impacts. Uranium mining and milling create vast quantities of tailings; runoff from these tailings can contaminate both surface and groundwater. Contaminants include not only uranium and other radioactive materials, but also toxic heavy metals. The radioactive and other toxic impacts of uranium mine and mill tailings are extremely long lasting; improper disposal and handling in the past continue to cause harm in the present.

**Natural gas production:** Technological advancements in hydraulic fracturing (fracking) have enabled massive expansion in the production of unconventional gas. The process involves many known risks to ground- and surface-water quality.

- During fracking, fractures in the rock may create pathways for the migration of methane or fracking fluid into overlying aquifers, contaminating groundwater with explosive levels of natural gas. Faulty well construction can also lead to migration of gas from wells into groundwater. An estimated 3 to 7 percent of wells have compromised structural integrity, a problem that could enable methane to seep into groundwater.
- Seepage of fracking fluids into groundwater has contaminated drinking water with toxic chemicals such as benzene. Only a portion of fracking fluids are recovered in the “flowback water” from a well; the remainder is left deep within the earth, potentially leading to groundwater contamination.
- Concern over water supply contamination is intensified by the fact that many fracking chemicals are not currently regulated by the Safe Drinking Water Act, and the precise mix of chemicals used in fracking is often kept secret.
- As wells begin to produce gas, additional water originally present in the surrounding rock formation mixes with the fracking fluid and surfaces as “produced water.” This water may contain salts, metals, oil, grease, benzene, toluene, radioactive materials naturally occurring in the rocks, and chemicals used in fracking.
- In the Marcellus Shale region, fracking wastewater is either reused, or sent to municipal wastewater treatment facilities where it is treated and discharged into local surface waters. These municipal facilities are not designed to deal with the contaminants that are found in fracking wastewater. High concentrations of salts and naturally occurring radioactive material cannot be removed by these facilities, and are passed through to local water bodies. Similarly, cuttings from the well may be sent to landfills, where the radioactive material can migrate into water that is then treated and released by wastewater facilities incapable of adequately handling the waste.

Power plant waste disposal is another major source of water quality impacts. Wastewater discharges from power plants currently account for 50 to 60 percent of all toxic pollutants discharged to surface waters by all industrial sources regulated by the EPA. Water quality impacts from the operation of thermoelectric power plants include the following:

**Flue gas desulfurization (FGD) wastewater:** Coal fired power plants produce wastewater through a number of processes, including from FGD systems (scrubbers), which reduce sulfur emissions. The slurry produced by a scrubber contains high levels of arsenic, mercury, aluminum, selenium, cadmium, and iron. Most plants using scrubber discharge their wastewater to settling ponds. After a certain amount of residence time in the pond, the wastewater is generally discharged to local surface waters. Although this process may effectively reduce total suspended solids and other particulate pollutants, it does not reduce the potentially significant amounts of dissolved metals in the wastewater. Thus several pollutants—such as boron, manganese, and selenium—can be discharged untreated into the environment.

**Coal combustion residuals (CCR):** Coal-fired plants produce vast amounts of fly ash, bottom ash, and boiler slag, known as coal combustion residuals. Typically, CCR contains heavy metals and radioactive material. An estimated 131 million tons of CCR were produced in 2007, of which about 43 percent was recycled; the rest remains in surface impoundments near the plants, or was dried and landfilled. EPA lists over 670 coal processing waste and CCR sites, of which 45 have been identified as “high hazard” sites. The potential impacts to water from CCRs include leaching of pollution from impoundments and landfills into groundwater, and structural failures of impoundments leading to spills. During the past several decades, there have been several documented cases of ground or surface water contamination. A 2007 draft risk assessment for EPA found significant human health risks for people living near clay-lined and unlined sites from contaminants including arsenic, boron, cadmium, lead, and thallium. To date, CCR has been exempt from federal regulation and has been regulated at the state level. Following a devastating spill in Tennessee in 2010, the EPA proposed to regulate CCR impoundments for the first time ever under the Resource Conservation and Recovery Act, but the rule has yet to be finalized.

**Thermal pollution:** In once-through cooling systems, large quantities of water are withdrawn from rivers, lakes, or other water bodies, used for cooling, and then discharged at a much higher temperature. Thermal discharges from power plants can alter the populations of phytoplankton; increase the likelihood of algal blooms; accelerate the growth of bacteria; increase mortality of copepods,<sup>2</sup> snails, and crabs; and alter fish habitats, with uncertain results. Thermal pollution regulations can limit the ability of power plants with once-through cooling systems to operate during heat waves, which may become more common under climate change. If the incoming river, lake, or ocean water is too warm, it will cool the power plant less efficiently, and the outflow from the plant may exceed the allowable temperature limits for thermal discharge. This can lead to the need to purchase high-cost replacement power, which affects electricity rates paid by consumers.

### C. The Information Gap: Data Needs for Sustainable Energy Planning

This study has identified several information gaps that need to be filled in order to support energy planning, regulations, and policymaking that fully account for water constraints and impacts. Critical data deficiencies are summarized below.

**Power plant data collection and reporting:** Although average water usage by thermoelectric technologies has been studied and documented, plant-level water usage data is of insufficient quality and detail. Many power plants do not report their water use to the EIA; outdated forms used by the EIA have resulted in reporting inaccuracies; and U.S. Geological Survey data—an essential source for water planning—have several critical shortcomings. These data deficiencies limit the ability of government agencies and industry analysts to identify trends in water use and looming intersectoral conflicts. On a national level, water availability and use has not been comprehensively assessed in more than 30 years. Directed by the SECURE Water Act of 2009, the USGS has begun an assessment (or census) of water availability, but the final product will likely not be available for many years.

---

<sup>2</sup> Copepods are small crustaceans which are an important food source for many fish.

**Climate change impacts and uncertainty:** The inadequacy of information about the impacts of climate change stems primarily from the complexity of the climate problem. Despite the massive and ever-expanding body of research, crucial questions about the pace of climate change remain uncertain, perhaps inescapably so. The long-term pace at which the global average temperature is rising remains uncertain, and downscaling of global forecasts to regional levels introduces additional uncertainty. Dissemination of information on climate impacts and sensible discussion of climate policy are further constrained by vociferous opposition from groups and individuals who are committed to denying the overwhelming scientific consensus about the reality of the climate threat.

**Groundwater unknowns:** Groundwater provides about 40 percent of the nation’s public water supply, and a significant portion of its irrigation water. As additional water supplies are sought to provide water for power plants, coal mines, and natural gas wells, groundwater aquifers will suffer faster rates of depletion and may quickly be exhausted. The overdraft of aquifers is enabled in part by inadequate monitoring of aquifer levels and a virtual dearth of pumping regulations. The absence of a national groundwater-level network with a unified objective and reporting protocols makes interstate groundwater resources exceedingly difficult to manage, precluding accurate assessments of groundwater availability, rates of use, and sustainability.

**Water rights uncertainty:** Several factors—including poorly understood surface water variability, groundwater movement, and climate change impacts—are combining to erode the security of users’ water rights. Moreover, no agreements (or insufficiently clear and detailed agreements) are in place to deal with water shortages in countless river basins and aquifers. As water shortages loom on the horizon, policymakers need access to the most accurate information available regarding water flows. Lack of comprehensive agreements has already led to protracted legal battles, and will likely lead to more in the future unless policymakers make the resolution of this issue a priority.

**Reporting of chemicals used in fracking:** Gas producers often designate the identities of the fracking chemicals they use as “proprietary information” or “trade secrets.” Many known toxins and carcinogens are used in fracking, but determining which chemicals are used in any particular well is a challenge. A few states require some disclosure regarding fracking chemicals; however, more than half of the states with fracking activity currently have no disclosure requirements at all. The Natural Resources Defense Council found that only six states allow disclosure of trade secret information to health care providers who are treating patients exposed to fracking fluid.

**FGD wastewater treatment effectiveness:** The quality of data measuring the effectiveness of FGD wastewater treatment is inadequate across the power plant sector, due to inconsistent definitions of what is considered “wastewater” across the industry, and the varying levels of treatment systems used.

## D. Recommendations

The energy sector’s dependence on and unsustainable use of water threatens the reliability of our nation’s energy system and the health of our water supplies. To address these risks, we must fill the information gaps present in our understanding of the issues, and account for water-related risks in energy planning, regulations, and policies.

At a minimum, we recommend that regulators and policymakers:

- Conduct long-term water resource planning on a regional basis and across sectors, including projections of future water needs and the possible impacts of droughts and climate change on water availability.
- Require entities proposing to construct new power plants or retrofit existing plants to conduct water resource adequacy assessments, as well as incorporate the future opportunity cost of water in a power plant's cost estimates.
- Perform electric generation risk assessments related to the ability of power plants to continue operation during heat waves and extended droughts.
- Encourage existing power plants to explore alternative cooling technologies and water sources, such as using reclaimed or brackish water, using thermal discharges to desalinate water, or using air cooling systems.
- Incorporate the costs of alternative cooling technologies, the water sources required to operate them, and anticipated carbon prices in analyses of the economic viability of thermoelectric plants in an increasingly water- and climate-constrained world.
- Encourage investments in energy efficiency and renewable technologies that require little water.
- Review all federal and state water subsidies and continue to provide subsidies only if they are supported by a thorough assessment of the social and economic impacts of water supply on all sectors, including agricultural, municipal, industrial, and indigenous tribal users of water, as well as the energy sector.

In addition, information about and regulation of the water quality impacts of fuel extraction and wastewater disposal must be strengthened. In particular:

- More information is needed regarding the chemicals present in treated wastewater and fracking fluids.
- Regulations regarding the use and storage of such chemicals must be tightened.
- Mine reclamation needs to be held to high standards, restoring or replacing the previously existing ecosystems.
- Any renewal of uranium mining needs to be carefully regulated to control the dangers of radioactive contamination.



# 1. Introduction

Water is increasingly becoming a limiting factor on U.S. energy production, and a key obstacle to business-as-usual. The constraints range from insufficient water supplies to meet power plants' cooling and pollution control needs—a challenge likely to be exacerbated by climate change, population growth, and competition from other sectors—to the high costs of energy-related water contamination and thermal pollution.

This report examines multiple water-related issues facing the U.S. electricity industry, and provides recommendations to address major risks associated with energy and water interactions.

We begin by reviewing water quantity constraints in the U.S., and the relationship of those constraints to the electric sector. We then examine the impact of power plant operations and fuel production on water quality. Our review of these issues is framed in terms of the constraints and impacts that are “known” (well researched, better understood, and addressed to some extent by planning or regulations), and those that are “unknown” (poorly understood).

Examples of “known” challenges include the vulnerability of thermoelectric power plants to droughts, and the potential impacts of coal, oil, and natural gas extraction on water availability and quality. Examples of “unknown” challenges include the impacts of climate change, and the nature of health impacts associated with shale gas hydraulic fracturing.

Table 1 summarizes the myriad water quantity and quality challenges associated with electricity production.

**Table 1. Water Quality and Quantity Challenges of Electricity Production**

	Known Challenges	Unknown Challenges
<b>Water Quantity</b>		
<b>Power Plant Water Use</b>	Thermoelectric generators withdraw and consume enormous amounts of water for cooling and emissions removal purposes.	Future adoption of recirculating cooling systems (to comply with 316(b) regulations) will decrease withdrawals but increase total water consumption by power plants. Implementation of CCS technologies could significantly increase power plant water consumption.
<b>Fuel Extraction and Production</b>	Large quantities of water are used for mining, processing, and transporting coal, oil, and natural gas. Depending on the region and crop, vast quantities of water may also be used for irrigating energy crops.	Expansion of new fuels, such as oil shale or energy crops, could require much more water than is currently used for fuel production.
<b>Additional Water Demands</b>	Growing populations, particularly in the Southwest, will increase the water required for supporting agriculture and domestic uses.	To meet the energy needs of growing populations living in a warming climate, water demands for energy production from thermoelectric power plants could increase significantly.
<b>Water Availability</b>	Recent droughts have required power plants to make expensive infrastructure investments or curtail output during droughts due to inadequate water supplies.	Climate change will increase the frequency of droughts and decrease runoff in some regions of the United States. Some areas may experience water shortages that will threaten the ability of thermoelectric plants to obtain sufficient water for cooling or well operators to access water for natural gas production. Hydroelectric plants may also be negatively impacted as the timing and magnitude of river flows shift.
<b>Legal and Regulatory Uncertainty</b>	Power plants may face legal challenges from other users over water rights.	As droughts become more frequent and water demands from other sectors increase, intersectoral and interstate conflicts may arise. Regulators may reduce or reallocate water from the electric power sector to meet other needs.
<b>Water Quality</b>		
<b>Coal, Uranium, and Oil Extraction</b>	Tailings, runoff, and mine drainage can release toxic chemicals, including heavy metals and radioactive waste, into water supplies.	
<b>Natural Gas</b>	Natural gas wells, particularly those using hydraulic fracturing, can contaminate surface and groundwater with produced water, hydrocarbons, and toxic chemicals.	In many states, the chemicals used in hydraulic fracturing are not disclosed to the public.
<b>Wastewater</b>	Wastewater is generated through many processes including the removal of sulfur from coal plant emissions, the coal washing process to remove heavy metals, the disposal of coal combustion residuals, and the disposal of hydraulic fracturing water. The improper treatment and disposal of such wastewater can result in contamination of other water sources and negative health and environmental impacts.	The effectiveness of wastewater treatment plants varies. It is not known whether released wastewater is always sufficiently treated. New EPA rules governing such systems are expected in 2014.
<b>Thermal Pollution</b>	High-temperature cooling water discharges may be harmful to aquatic species. During heat waves, power plants may be restricted from discharging warmed water into sensitive water bodies, forcing power plants to curtail operations.	Climate change may increase the frequency of restrictions on thermal discharges from power plants to water bodies, reducing electricity production.

Section 4 of this report identifies information gaps that need to be filled in order to address water quantity and quality challenges, and to support sustainable energy planning. Section 5 presents case studies of two U.S. states with different water limitations (Ohio and Colorado), as a mechanism to explore in greater detail existing and future challenges related to water and the electric sector. While the states differ widely in water supplies, both are facing serious water impacts from energy production, including significant risks of pollution from shale gas hydraulic fracturing.



Section 6 recommends actions that regulators and policymakers can take to address the key challenges examined in this study. Our recommendations in this analysis build on the findings of the “Hidden Costs” study that Synapse performed for CSI in 2012. “Hidden Costs” identified numerous water-related impacts of electricity production, depending on fuel type. Water impacts were generally most significant for coal, nuclear, and natural gas-fired power; intermediate for biomass and concentrating solar power; and minimal for wind and solar photovoltaics. (Energy efficiency measures have minimal water impacts, as well.) The seriousness of water problems described in the case studies emphasizes the need to move toward energy technology choices with lower water impacts.

## 2. Energy Production in a Water-Constrained World

The amount of water available to serve diverse needs is a growing concern across the country, from the arid western states to the seemingly water-rich Southeast. The historic drought of 2012 has only intensified longstanding controversies associated with water apportionment among cities, power plants, and agriculture. Power plants are increasingly at the heart of these controversies, since they account for nearly half of the 400 billion gallons of water that are withdrawn daily in the United States. Examples of recent conflicts include the protests surrounding a proposed nuclear plant's water withdrawals in Utah; the tri-state water war involving Georgia, Alabama, and Florida; and numerous local debates regarding power plant siting around the country.<sup>3</sup>

Although some thermoelectric plants use simple combustion turbines, most use steam turbines. Water is used to create the steam that turns the generator turbines, for cooling purposes, and for operating environmental control systems. The vast majority of thermoelectric power in the United States is fueled by coal, uranium, and natural gas, although thermoelectric power plants may also include geothermal energy, solar thermal systems, and biomass combustion (Cooley, Fulton and Gleick 2011). In this report we focus on the water requirements and impacts of the three primary forms of thermoelectric energy—coal, nuclear power, and natural gas—and briefly investigate the water-related issues associated with hydroelectricity and biomass.

A recent analysis by the Union of Concerned Scientists identified and mapped the watersheds of the United States experiencing the most stress (Figure 1), where “water stress” is defined as demand in a watershed exceeding 40 percent of the locally available supply (Averyt, Fisher, et al. 2011). While the majority of water stress occurs in the West, power plants were found to be the primary driver of stress for many of the watersheds under pressure in the East.

---

<sup>3</sup> See, for example “Nuclear Power Proposal in Utah Reignites a Century-Old Water War,” describing the controversy surrounding the proposed nuclear facility on the Green River in Utah by David Hasemyer for Reuters (<http://www.reuters.com/article/2012/04/17/idUS300531460620120417>). Also see a description of the Southeast's tri-state water wars in *The Economist*: “Water Wars in the Southeast: Chattahoochee Blues” (<http://www.economist.com/node/17043462>)

Figure 1. Water Supply Stress in the United States

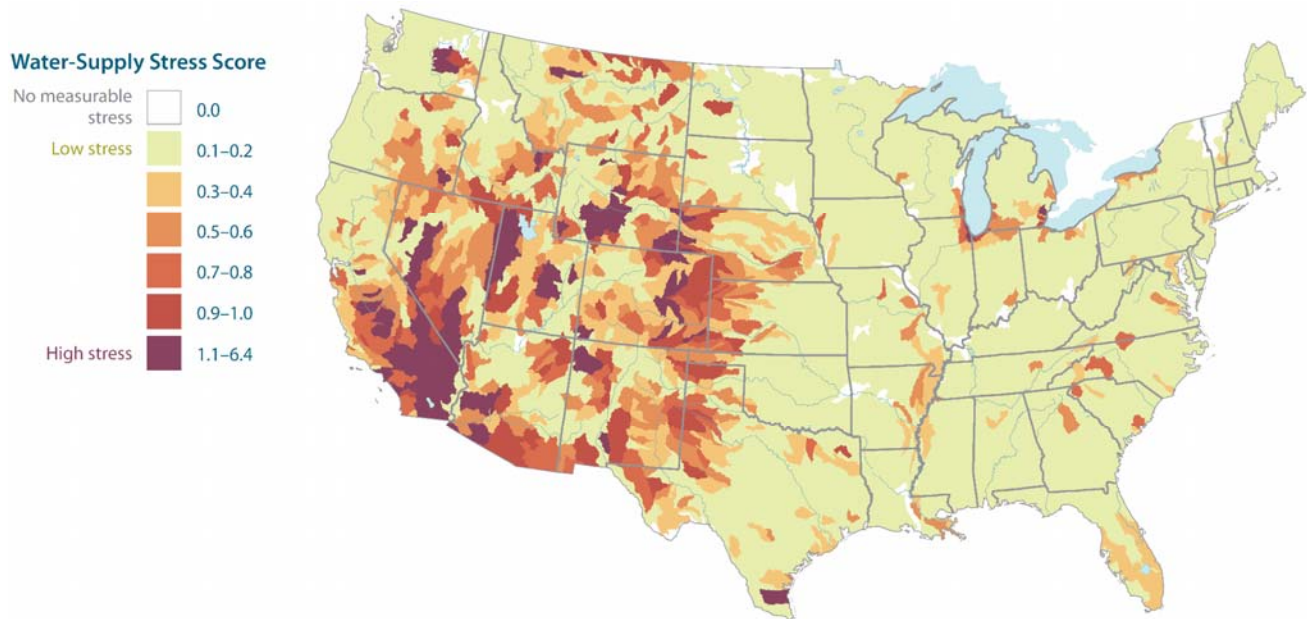

This map of water stress represents current conditions. In the future, as the population continues to expand (for example, in the fast-growing, already water-stressed Southwest) and as demand continues to rise for water for electricity production, water resources will be squeezed even further – unless actions are taken to reduce our dependence on water-intensive forms of energy.

In the following sections, we examine known water quantity challenges resulting primarily from increasing energy demand, as well as “unknown” (less well understood) challenges resulting from climate change and regulatory uncertainty.

## A. Known Water Quantity Constraints

### *Limited Supplies and Growing Water Demands*

Recent estimates of power plants’ water withdrawals range from 141 billion<sup>4</sup> to more than 200 billion gallons per day (Kenny, et al. 2009). Some of the water withdrawn by thermoelectric plants is saline water—either seawater or from saline aquifers. However, even considering only freshwater withdrawals, the quantity of water withdrawn for electricity production is enormous and growing. This growth comes at a time when surface water resources are already stretched to the limit in much of the Southwest and other regions, while groundwater overdraft and sinking water tables plague many parts of the country.

---

<sup>4</sup> Estimated by Synapse Energy Economics using Union of Concerned Scientists data compiled from Energy Information Administration data and median water withdrawal/consumption rates from Macknick et al. 2011. Data available in the *UCS EW3 Energy-Water Database V.1.3*, 2012, [www.ucsusa.org/ew3database](http://www.ucsusa.org/ew3database).

Thermoelectric plants withdraw more fresh water (40.8 percent of the total) than any other sector, including agricultural irrigation (36.8 percent) and municipal/domestic supply (13.8 percent), as illustrated by Figure 2 (Kenny, et al. 2009). Moreover, additional water is required to mine, process, and transport the fuel used in thermoelectric generation, as described below.

Figure 2. Freshwater withdrawals in the United States in 2005.

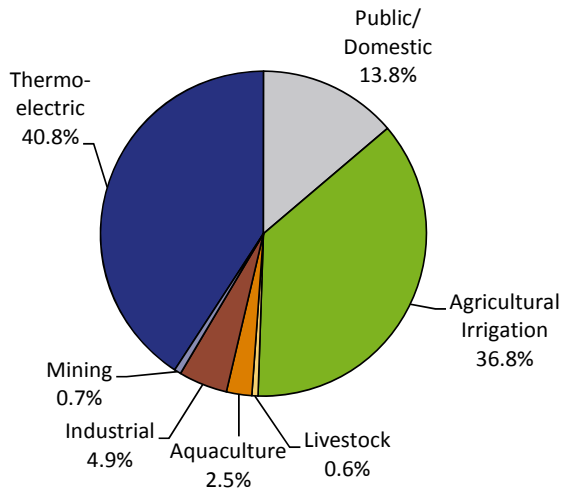

Source: Kenny et al. (2009)

While much of the water withdrawn for electricity production is returned (at higher temperatures) to the sources of withdrawal or other natural water bodies, losses to evaporation can be high, depending on the type of cooling system used. “Consumptive use” refers to the amount of water not returned to the immediate water environment due to evaporation, transpiration, incorporation into products or crops, or consumption by humans or livestock (Kenny, et al. 2009). Only about 3 percent of water withdrawn for electricity is consumed, yet this still amounts to about 4 billion gallons per day.

Both water withdrawals and evaporative water losses are of concern in areas where water demands already exceed, or are projected to exceed, water supplies. Water withdrawal rights held by power plants may conflict with upstream uses such as agriculture or municipal use, while evaporative losses from power plants also make the water unavailable to subsequent users in that watershed.

The large proportion of water used by power plants is increasingly problematic, considering that the national population is expected to grow rapidly over the coming decades, rising by more than 100 million by 2060 (U.S. Census Bureau 2012). Electricity demand will continue to increase, driven by a combination of a growing population, larger incomes, and migration to warmer regions with higher cooling requirements (U.S. Energy Information Administration 2012).

Demand for electricity is expected to grow by 22 percent from 2010 to 2035, and a significant part of this additional demand will come from the southwestern states (Arizona, New Mexico, Colorado, Nevada, and Utah) that face some of the greatest water stress in the country. The population of this region is projected to increase by 70 percent between 2000 and 2030—more than double the national average rate of growth (U.S. Census Bureau 2005).

Greater electricity demand means that energy production will increasingly compete with agriculture, industry, and households for limited supplies of water in water-stressed areas. The effects of climate change—particularly higher temperatures and more frequent droughts—are likely to exacerbate these trends, as discussed in the following section, while threatening the ability of power plants to operate during heat waves and droughts.

### **Water for Energy: Thermoelectric Power**

Water is integral for thermoelectric power production, whether the fuel is coal, natural gas, uranium, oil, or biomass. Coal and nuclear plants are the largest water users, accounting for 60 and 32 percent of total withdrawals by U.S. thermoelectric plants, respectively.<sup>5</sup> On an average day, water withdrawals amount to an estimated 85 billion gallons for coal plants, 45 billion gallons for nuclear plants and 7 billion gallons for natural gas plants. These amounts dwarf the current daily water withdrawals of other energy sources, as shown in Figure 3.

**Figure 3. Estimated Daily Water Withdrawals for Electricity Generation in the United States**

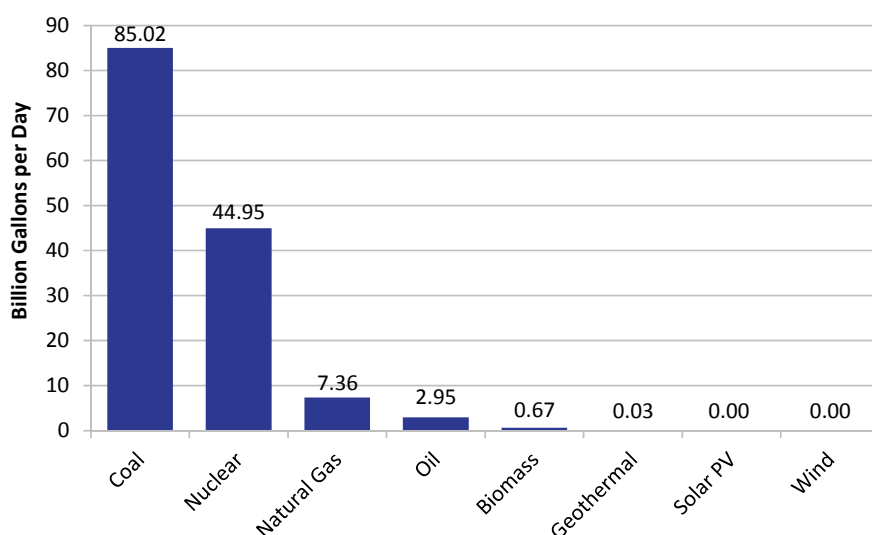

Source: Estimated by Synapse Energy Economics using the Union of Concerned Scientists' UCS EW3 Energy-Water Database V.1.3, 2012. Database sources include EIA data and Macknick 2011 withdrawal coefficients.

Prior to generation, fuel for thermoelectric plants must be mined, processed, and transported, all of which also require water. In contrast, many renewable resources such as wind and solar photovoltaics (PV) require very little water.

During the 1980s, important advances were made in thermoelectric power technology that reduced power plant water consumption. However, since 1990 thermoelectric water withdrawals

<sup>5</sup> Estimated by Synapse Energy Economics using Union of Concerned Scientists data compile from Energy Information Administration data and median water withdrawal/consumption rates from Macknick et al. 2011. Data available in the UCS EW3 Energy-Water Database V.1.3, 2012, [www.ucsusa.org/ew3database](http://www.ucsusa.org/ew3database).

have been growing at the rate of 1.3 percent per year,<sup>6</sup> largely due to increasing electricity demand.

Despite investment in renewable energy technologies over the past two decades (particularly wind and solar photovoltaics), thermoelectric output has continued to rise to meet increasing demand, and its share of U.S. electricity generation remains close to 90 percent. Recent declines in coal generation have been offset by generation from other thermoelectric sources, particularly natural gas and non-woody biomass. Between 2001 and 2011, electricity from natural gas increased 59 percent, while “other biomass”—which includes energy crops—rose 32 percent. At the same time, electricity production from hydroelectric facilities has remained relatively stable, at about 7 percent of total U.S. electric output (U.S. Energy Information Administration 2012b).

Figure 4. Electricity Generation by Source Type

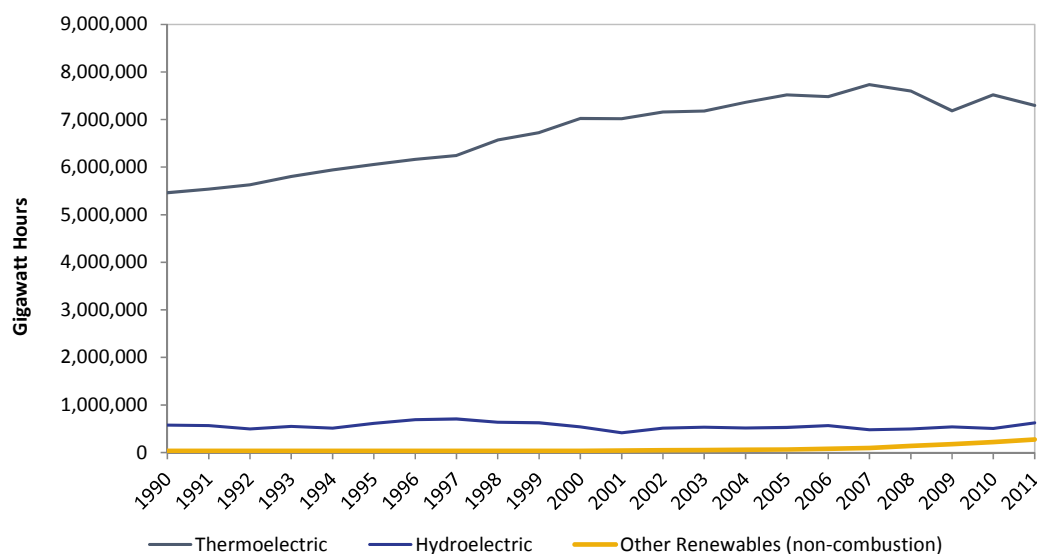

Source: EIA (2012) *Net Generation by Energy Source* based on EIA-906, EIA-920, and EIA-923. Thermoelectric includes coal, petroleum, natural gas, other gases, nuclear, wood and wood-derived fuels, other biomass, and other. Hydroelectric includes conventional hydro and pumped storage. Renewable non-combustion includes solar thermal, photovoltaics, wind, and geothermal.  
[http://www.eia.gov/electricity/data/state/annual\\_generation\\_state.xls](http://www.eia.gov/electricity/data/state/annual_generation_state.xls)

Thermoelectric power output experienced a temporary dip during the recent recession, but growth is generally expected to resume as electricity consumption increases. The EIA projects electricity produced by biomass will expand by 6 percent per year through 2035 (i.e., almost quadrupling over current levels), producing 145 billion kilowatt hours in 2035, in large part due to its ability to satisfy state renewable energy mandates. Natural gas is likewise projected to increase significantly, with electricity generation from natural gas rising 31 percent by 2035.<sup>7</sup> Electricity from

<sup>6</sup> Estimated by Synapse Energy Economics using USGS water data through 2005.

<sup>7</sup> EIA's 2012 *Annual Energy Outlook* reference case (full report) projects that natural gas electricity generation in 2035 will total 1,398 billion kWh, compared to 1,066 kWh in 2012. Coal and nuclear power are expected to generate 1,897 billion kWh and 887 billion kWh in 2035, respectively, up from 1,709 and 813 billion kWh in 2013.

nuclear power and from coal is projected to grow by 9 percent and 11 percent, respectively, over the same time period.

Without new policy interventions, traditional thermoelectric and hydroelectric sources will continue to produce the vast majority of electricity for decades to come (U.S. Energy Information Administration 2012). Yet these resources require vast amounts of water, and overreliance on them leaves us vulnerable to water shortages and plant shut-downs during heat waves and droughts.

### **Thermoelectric Power: Water for Cooling**

Cooling technologies for power plants include both wet (water) and dry (air) cooling, with wet cooling being the dominant method. The amount of water a power plant consumes and withdraws for cooling is based primarily on whether the wet cooling system is once-through (also called “open-loop”) or recirculating (also called “closed loop”)<sup>8</sup> (Kenny, et al. 2009).

**Once-through cooling systems** withdraw water from a nearby water body, typically a river or lake, and then pass the water through a heat exchanger to condense the steam used to turn the turbines. The cooling water is then discharged to a surface-water body at an elevated temperature.

Withdrawal rates for once-through cooling systems are immense. On average, a 500 MW coal power plant operating at full capacity withdraws more than 18 million gallons of water per hour, while the same size nuclear power plant withdraws 22 million gallons of water per hour.<sup>9</sup> Expressed in terms of electricity production, nuclear power plants using once-through cooling systems withdraw nearly 45,000 gallons of water per megawatt hour, while coal and natural gas power plants with once-through cooling withdraw on average 36,000 gallons and 27,000 gallons per megawatt hour, respectively.

These rates imply massive annual water withdrawals by thermoelectric power plants with once-through cooling systems. For example, a 500-megawatt coal plant running at an 80 percent capacity factor would generate more than 3.5 million megawatt hours of electricity per year, entailing total annual withdrawals of 126 billion gallons of water – equivalent to the annual water use of 3.8 million people.<sup>10</sup> Such high withdrawal rates require large, reliable water supplies, and may make power plants vulnerable to droughts or claims from upstream agricultural, industrial, or municipal users.

Once-through cooling systems were the conventional technology until the early 1970s (Mielke, Anadon and Narayanamurti 2010), and these systems are still used by approximately 40 percent of thermoelectric plants in the United States (U.S. Energy Information Administration 2013).

---

<sup>8</sup> Recirculating systems may use either cooling towers or cooling ponds, but cooling towers are the dominant method. The water use associated with cooling ponds can vary greatly; we have thus chosen to focus on recirculating systems with cooling towers. In this report, therefore, “recirculating” implies use of a cooling tower.

<sup>9</sup> Estimated using Energy Information Administration data compiled by the Union of Concerned Scientists. Data available in the *UCS EW3 Energy-Water Database V.1.3*, 2012, [www.ucsusa.org/ew3database](http://www.ucsusa.org/ew3database).

<sup>10</sup> According to the USGS, the average American uses approximately 90 gallons per day, or 32,850 gallons per year (<http://ga.water.usgs.gov/edu/ga-home-percapita.html>).

However, as discussed below, once-through cooling is being phased out in the United States by the Environmental Protection Agency (EPA).

Section 316(b) of the Clean Water Act requires that the location, design, construction, and capacity of cooling water intake structures reflect the best technology available for minimizing adverse environmental impacts—particularly the entrainment and impingement of fish and other aquatic organisms during cooling water intake. In 2001, the EPA adopted regulations that determined recirculating cooling systems to be the best technology available for new power plants (66 Fed. Reg 65255 (December 18, 2001)). Regulations regarding existing power plants are under development and are discussed in the following section.

**Recirculating systems** withdraw water from a source, pass the water through the condenser for cooling, and then transfer the water to ponds or cooling towers. Once the heated water cools, the water is recirculated through the system. This form of cooling is widely used at power plants in more arid regions of the United States, as the amount of water withdrawn is far lower than once-through systems.

Figure 5 compares the average water withdrawn per megawatt hour of energy produced by coal, natural gas combined cycle,<sup>11</sup> and nuclear power plants, using either a once-through or recirculating cooling system.<sup>12</sup> While not included in the graph, withdrawal rates for biomass plants are similar to those for coal (National Energy Technology Laboratory 2013).

---

<sup>11</sup> Simple-cycle natural gas combustion turbines use only small amounts of water, as there is no steam cycle equipment. In contrast, natural gas combined cycle units (which combine a combustion turbine with a steam turbine) use much more water and are therefore the focus of our analysis of natural gas plants (Maulbetsch and DiFilippo 2006). In addition, combined cycle natural gas electricity generation comprises the majority of natural gas electricity production (U.S. Energy Information Administration 2012).

<sup>12</sup> Although “recirculating” can technically refer to both wet and dry cooling, in this report we use the term to refer to wet cooling systems only. We focus on natural gas, coal, and nuclear due to their large shares in energy production. Other fuels, such as petroleum and biomass, comprise a much smaller proportion of the share of electricity generation.



**Figure 5. Average Withdrawals of Thermoelectric Power Plants in the United States by Fuel Source and Cooling System**

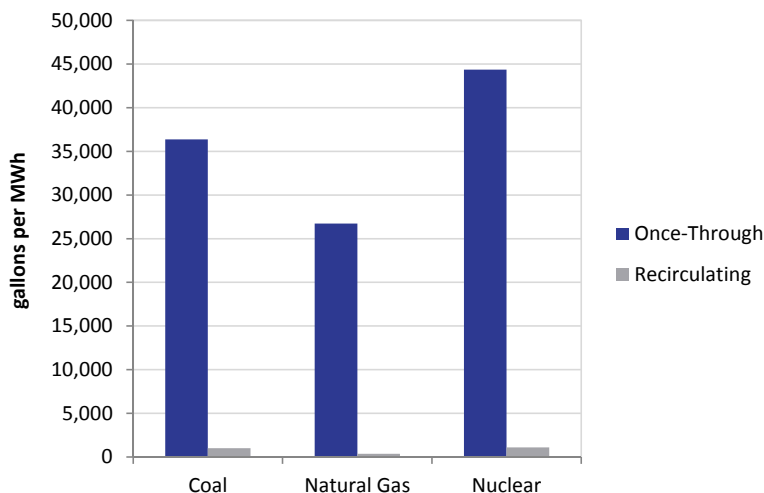

Source: Estimated by Synapse Energy Economics using the Union of Concerned Scientists' UCS EW3 Energy-Water Database V.1.3, 2012. Database sources include EIA data and Macknick (2011) withdrawal coefficients.

While water withdrawals for once-through cooling systems are far greater than for recirculating systems, the relationship is reversed when measuring water consumption (the amount of water not directly returned to a natural water body due to losses from evaporation), as shown in Figure 6. On average, recirculating systems consume more than twice as much water as once-through systems (Macknick, et al. 2011). In addition, the costs of recirculating systems are about 50 percent higher than once-through systems (Mielke, Anadon and Narayanamurti 2010). Approximately 47 percent of U.S. thermoelectric power plants use recirculating systems.<sup>13</sup>

Coal and nuclear power plants using recirculating systems consume nearly 700 gallons per megawatt hour. Natural gas combined cycle consumption is lower but still significant, at nearly 300 gallons per megawatt hour. (Notice the very different scales used in Figure 5 and Figure 6.)

<sup>13</sup> Approximately 10 percent of power plants use cooling ponds, while 3 percent use dry cooling systems. Water withdrawals and consumption rates of cooling pond systems may vary significantly, and are therefore not described in detail in this report. Dry systems represent an alternative to wet-cooling systems, but, as described elsewhere in the report, they may be prohibitively costly, and may entail substantial efficiency penalties.

**Figure 6. Water Consumption of Thermoelectric Power Plants in the United States by Fuel Source and Cooling System**

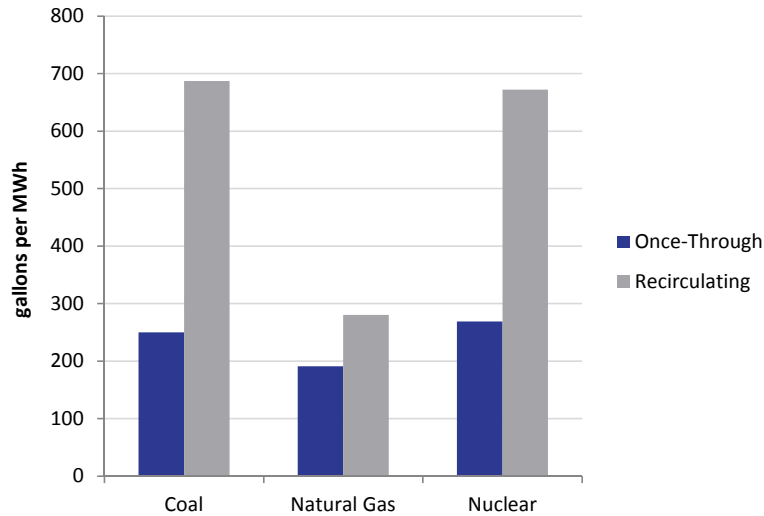

Source: Estimated by Synapse Energy Economics using the Union of Concerned Scientists' UCS EW3 Energy-Water Database V.1.3, 2012.

**Dry cooling** (air cooling) is similar to wet recirculating systems, except that the cooling towers use only air to expel waste heat. Dry cooling uses nominal amounts of water, and lowers the overall plant efficiency by approximately 2 percent on average. However, in the peak of summer when demand is highest, the efficiency penalty for dry cooled systems can be as high as 25 percent (U.S. Department of Energy 2006). Capital costs for dry cooling systems can also run more than eight times higher than costs of once-through cooling systems (Mielke, Anadon and Narayanamurti 2010). Dry cooling is used by 3 percent of U.S. thermoelectric plants, almost all of them natural gas plants.

### **Thermoelectric Power: Water for Emissions Control Equipment**

Increasingly stringent environmental regulations have required thermoelectric plants to adopt strategies for controlling emissions of certain pollutants. The regulation of sulfur dioxide, a pollutant responsible for acid rain, has resulted in numerous coal and oil generators installing flue gas desulfurization (FGD) scrubbers, with 58 percent of electricity from coal now generated by coal plants with such scrubbers (U.S. Energy Information Administration 2011). The reduction of sulfur dioxide air emissions using FGD scrubbers generally requires higher water withdrawals and consumption—adding approximately 100 gallons per megawatt hour to coal plants' consumption rates (Klett, et al. 2007).

Water required to remove sulfur dioxide is dwarfed, however, by the water required by carbon capture and sequestration (CCS) technologies. While CCS is not yet widely used, and the first commercial-scale power plants with CCS are still under construction (Center for Climate and Energy Solutions 2012), this technology could become widely adopted to comply with the EPA's

New Source Performance Standards for new power plants,<sup>14</sup> and to reduce carbon emissions under a future climate policy.

Carbon capture and sequestration increases the water usage of coal and natural gas-fired power plants substantially, due to water requirements for CO<sub>2</sub> absorption, stripping, and solvent reclamation processes (see the appendix for further details). The National Energy Technology Laboratory estimates that pulverized coal units would consume 83 percent more water with the addition of CCS, while new integrated gasification units (IGCC) would consume 58 percent more. Existing natural gas units that add CCS are projected to increase their water consumption by 91 percent (National Energy Technology Laboratory 2010). The wholesale conversion of natural gas and coal plants to CCS would result in dramatic increases in the amounts of water withdrawn and consumed by thermoelectric plants in the United States.

### **Additional Water Use for Thermoelectric Energy**

Water use by nuclear, natural gas, coal, and biomass plants is not limited to steam, cooling, and emission control purposes. Estimates of additional water consumed through the extraction, processing, and transport of various fuels are shown in Figure 7.

**Figure 7. Fuel Extraction, Processing, Transport, and Storage Water Use**

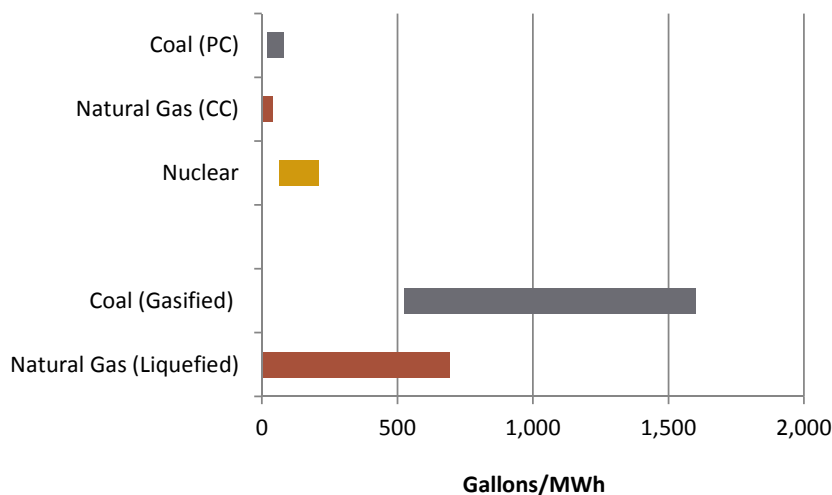

Source: Estimated by Synapse Energy Economics using data from Mielke, Anadon, and Narayanamurti (2010), U.S. Department of Energy (2006), and Waughray (2011).

Below we describe these water uses for each major form of thermoelectric power.

**Natural Gas:** Historically, most of the natural gas produced in the United States was from conventional (vertical) wells, where water consumption is negligible (U.S. Department of Energy 2006). In recent years, however, natural gas recovery from “unconventional” reservoirs such as

<sup>14</sup> In March 2012, the EPA proposed new standards for the emissions of greenhouse gasses from new power plants. These standards effectively require new carbon-intensive fuel sources to use carbon capture and sequestration technologies. No decision had been made about these standards as of May 2013.

“tight” (very low permeability) formations and shales has exceeded conventional production. Shale gas production in particular has risen sharply and is projected to more than double by 2035 (U.S. Energy Information Administration 2012).

Technological advances in horizontal drilling and hydraulic fracturing or “fracking” have played a key role in the dramatic increase in shale and tight gas extraction. These methods require significantly more water than conventional drilling. Fracking involves drilling vertically down thousands of feet, adding horizontal sections (which may themselves extend thousands of feet), and then injecting large quantities of fluids containing water, sand, and chemicals under high pressure. This process fractures the rock formation and releases trapped gas (U.S. Environmental Protection Agency 2013).

While estimates of water consumed in the drilling and fracking process range from 2 million to 5.6 million gallons per well (Mielke, Anadon and Narayanamurti 2010, ProChemTech International, Inc. 2009, Chesapeake Energy 2012a-f),<sup>15</sup> the intensity of the water consumption per MMBtu (million British thermal units) of natural gas depends on the total gas output of the well.<sup>16</sup> On average, water consumption for natural gas produced through fracking ranges from 0.6 to 1.8 gallons of water per MMBtu (Mielke, Anadon and Narayanamurti 2010).

In areas of water scarcity, the water consumed during fracking can place additional stress on water supplies and increase competition among users. Nationwide, almost half of shale gas and tight oil wells are being developed in regions exhibiting high or extremely high water stress (Freyman and Salmon 2013). As natural gas production from fracking continues to rise, adequate water supplies may become difficult to obtain and intersectoral conflicts are likely to intensify.

Processing and transporting natural gas typically requires water, ranging from 0 to 2 gallons per MMBtu (Mielke, Anadon and Narayanamurti 2010). Processing may require “sweetening” sulfur-contaminated natural gas using an amine-water solution, as well as glycol dehydration using an air- or water-cooled condenser (Lunsford and Bullin 1996, Eastern Research Group 1999). Water for gas transportation is related to hydrostatic testing of pipelines for leaks (Anonymous 2011).

Water consumption increases significantly if natural gas is liquefied using water-cooled equipment. To convert gas to liquefied natural gas (LNG), the gas must be compressed and cooled to around -160°C, which requires the removal of heat using a cooling medium, such as sea water, fresh water (with or without cooling towers), or air (Ferguson 2011). Gas-to-liquids (for use as transportation fuels and specialty chemicals) involves a liquefaction process that requires an average of 42 gallons per MMBtu, but may range as high as 86 gallons per MMBtu (Mielke, Anadon and Narayanamurti 2010). These water requirements could become problematic if exports of LNG or gas-to-liquids increase while relying on water cooling as opposed to air cooling.

---

<sup>15</sup> Estimates in Mielke, Anadon, and Narayanamurti (2010) are based on Chesapeake Energy’s reported values for water consumption in four natural gas plays across the United States as of 2010. Chesapeake Energy is the second-largest producer of unconventional natural gas in the United States (Mielke, Anadon and Narayanamurti 2010).

<sup>16</sup> The amount of natural gas consumed by a power plant to produce a megawatt hour of electricity (i.e., the heat rate) varies by the technology and age of the plant. According to the EIA, in 2011, an average existing natural gas combined cycle plant required 7.6 MMBtu to produce one megawatt hour of electricity (U.S. Energy Information Administration 2013c).

Natural gas is primarily stored underground in depleted natural gas reservoirs, aquifers, or salt caverns. Salt caverns require the most water, as their creation involves injecting large amounts of water to dissolve the salt deposit, which is then converted to brine and disposed of. These caverns consume seven gallons of water to create one gallon of natural gas storage capacity, or approximately 500 to 600 gallons of water per MMBtu of gas storage capacity (U.S. Department of Energy 2006). Storage in salt caverns represents nearly 9 percent of current natural gas working underground storage capacity, but this amount is expanding rapidly, with a 19 percent jump from 2011 to 2012 alone. The total working natural gas storage capacity for salt caverns now totals approximately 360 billion cubic feet, out of a total of approximately 4,250 billion cubic feet of underground storage (U.S. Energy Information Administration 2012c, U.S. Energy Information Administration 2012d).

**Coal:** The Department of Energy estimates that coal mining consumes between 70 million and 260 million gallons of water per day. As coal is increasingly mined in the western United States in large, open-pit mines, the amount of water consumed for coal mining is likely to increase. Using Department of Energy data, Mielke, Anadon, and Narayanamurti (2010) estimated that open-pit mines require approximately 6 gallons per MMBtu. Appalachian coal, which is primarily mined underground, requires 1 gallon per MMBtu, plus an additional 1 to 2 gallons for washing (Mielke, Anadon and Narayanamurti 2010).

Mining—both in Appalachia and other regions—can also reduce the amount of water available for other uses by disrupting groundwater and surface water flows. More than 2,000 km of headwater streams in Appalachia have been buried by coal mining (Bernhard and Palmer 2011), while mine dewatering—the process of pumping out water from coal formations—can lower the groundwater table and flow patterns for miles (Grubert and Kitasei 2010).

Further processing and transport of coal may require additional water. Coal that is gasified or liquefied can consume an additional 50 to 100 gallons per MMBtu, primarily for cooling purposes, but also to feed steam-producing boilers and to remove impurities (Waghray 2011). Coal that is transported through a slurry pipeline uses more than 5 gallons per MMBtu on average (U.S. Department of Energy 2006).

**Nuclear:** Uranium mining requires similar amounts of water as coal, ranging from 1 to 6 gallons per MMBtu, based on whether it is mined from a surface or an underground mine, while uranium enrichment ranges from 4 to 8 gallons per MMBtu (Mielke, Anadon and Narayanamurti 2010).

**Biomass:** The water required to produce biomass depends on the type and source of the fuel. Feedstocks that are derived from waste products, such as agricultural, municipal, and forest product waste, require no additional water. Energy crops, on the other hand, are produced solely for energy and can be highly water intensive. Switchgrass (*Panicum virgatum*) and miscanthus (*Miscanthus x giganteus*) are two examples of energy crops that can be used to produce electricity.

### **Lifecycle Water Consumption for Thermolectricity**

Total water consumption for coal, nuclear, and natural gas includes the fuel extraction, processing, transportation, storage, and waste management stages, plus additional water used at power plants for cooling purposes and emissions controls. Figure 8 below displays estimated lifecycle

water consumption factors (not withdrawals) per megawatt hour of electricity produced for the primary forms of thermoelectricity. Biomass is not included due to the wide variability in water consumption based on vegetation type and location.

**Figure 8. Lifecycle Water Consumption for Electricity Generation Including Fuel Extraction, Processing, Transport, and Storage Water Use**

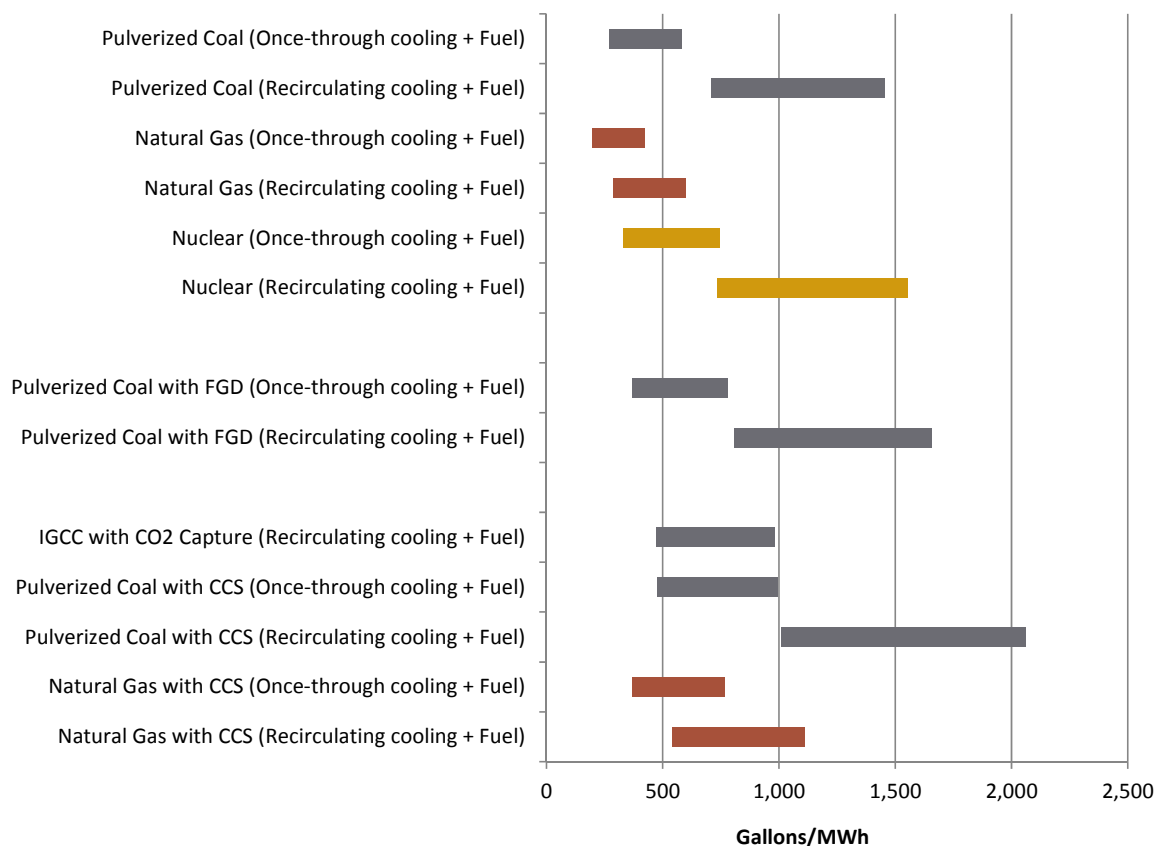

*Source: Estimated by Synapse Energy Economics using the Union of Concerned Scientists' UCS EW3 Energy-Water Database V.1.3, 2012g; Mielke, Anadon, and Narayanamurti (2010); U.S. Department of Energy; National Energy Technology Laboratory (2010) and (2009), and Waughray (2011).*

Generators using pulverized coal with recirculating cooling and carbon capture and sequestration (CCS) technology have the highest lifecycle water consumption levels, followed by coal and nuclear generators with recirculating cooling (and no CCS).

Integrated Gasification and Combined Cycle (IGCC) coal power plants with carbon capture consume less water than plants retrofit with CCS, but the consumption levels are still significant (similar to those of current coal plants), and IGCC power plants have not yet been proven commercially viable.

Due to EPA regulations for water and greenhouse gases, new coal plants will be constructed with both CCS and recirculating cooling systems—the combination with the highest water consumption shown above. As water resources become scarcer in many parts of the country, this may limit the ability of such plants to operate.

## ***Water for Energy: Hydroelectricity***

Approximately 7 percent of the nation's electricity comes from hydroelectric facilities (U.S. Energy Information Administration 2013b, U.S. Energy Information Administration 2012b). While the use of water by hydroelectric plants is “in-stream” i.e., water is not removed, a substantial amount of water from reservoirs can be lost to the atmosphere through evaporation (U.S. Department of Energy 2006). Gleick (1994) estimates that average losses from hydroelectric reservoirs in the United States amount to 4,500 gallons per megawatt hour. However, these reservoirs often serve other purposes (such as recreation and drinking water), and therefore not all the water lost can be attributed to electricity generation. Run-of-the-river hydroelectric plants, in contrast, divert river water to drive turbines and do not rely on large storage reservoirs, thereby avoiding much of the evaporation concerns of large dams.

Regardless of water consumption levels, a lack of water availability due to drought or other factors is a key vulnerability for hydroelectricity, as discussed below.

## ***Vulnerabilities of Power Plants to Water Shortages***

Already, lack of sufficient water has constrained power production in numerous cases, particularly during times of drought or due to conflicts with existing users. As water demands from all sectors grow, these constraints will likely occur more frequently and may threaten the reliability of energy supplies, the sustainability of natural ecosystems, and the growth of regional economies.

## **Drought**

Both thermoelectric and hydroelectric plants are vulnerable to reduced water availability during drought, particularly when also associated with heat waves. Higher outdoor temperatures warm the cooling water used by thermoelectric plants, which reduces operating efficiency. Heat waves also tend to trigger increased air conditioning demand, further elevating stress on the electric system when thermoelectric and hydroelectric plants may be least capable of providing full electrical output.

The severe drought of 2011 in Texas threatened to impact electricity generation. Although only one small, 24 MW power plant was forced to curtail operations due to inadequate cooling water availability, the drought raised the specter of much worse impacts to come. In October 2011, the Texas electric system operator, ERCOT determined that another six months of drought could result in 3,000 MW of capacity becoming unavailable (O'Grady and Choy 2011). The drought abated somewhat before such large curtailments became necessary, but by the fall of 2012 most of Texas was again swept by drought, and the Texas legislature began to consider extensive policy initiatives to secure more water supplies.

Even power plants in the southeastern United States—a region that typically experiences abundant precipitation—are vulnerable to water shortages and reduced power plant operations due to drought. Currently two-thirds of the region's freshwater is used for power plant cooling, and recent droughts have forced plants to shut down (Averyt, Fisher, et al. 2011). For example, in 2007 portions of Tennessee received less than two-thirds of average rainfall while experiencing record high temperatures, heating river water used for cooling. The reduced precipitation and runoff coupled with warmer temperatures caused output at the Tennessee Valley Authority's

(TVA) Cumberland coal plant to be cut by approximately 400 MW, while the Gallatin coal plant's output was reduced by about 50 MW (Tennessee Valley Authority 2007).

During drought, regions that rely heavily on hydroelectricity may be forced to purchase power from the market at inflated prices. TVA, which operates 30 dams that produce electricity, saw its hydroelectric output decline to 50 percent below normal during the drought of 2008. In response, TVA's power purchases from the market increased 12 percent, and the Authority warned customers that their bills would likely increase between 15 and 25 percent due to the high cost of purchased power. Purchased power costs for TVA in mid-2008 averaged around \$100 per megawatt hour, compared to typical hydro prices of around \$2 per megawatt hour (Powers 2008). Similarly, large price spikes were felt in 2001 in the Pacific Northwest, the most hydro-dependent region of the country, in part due to drought reducing the output of hydroelectric facilities (King 2008).

In the Southwest, drought is a persistent concern for both hydroelectric power and municipal water use. Lake Mead, a reservoir on the Colorado River, supplies much of the region with water, and with electricity from the 2,080 MW Hoover Dam. Throughout the 2000s, much of the region experienced chronic drought. Lake Mead water levels declined precipitously, dropping more than 100 feet from 2000 to 2011. Had the water levels dropped by approximately 30 more feet, the Hoover Dam would have lost enough hydraulic pressure to prevent it from generating electricity, while Las Vegas would have lost the use of one of its two intake pipes, and water deliveries to Los Angeles would have been greatly reduced (Quinlan 2010).

Drought may cause thermoelectric power plants to seek additional water supplies, typically at the expense of reduced water consumption in other sectors, such as agricultural or municipal water use. Procurement of additional water supplies (and corresponding water infrastructure projects) also increases costs for electric consumers.

During recent droughts, some plants, including Luminant's 2,250 MW coal plant in Texas and Duke Energy's 2,200 MW nuclear station in North Carolina, extended their water pipes or added additional pumps in order to accommodate lower reservoir levels or reach new supplies (O'Grady and Choy 2011, Averyt, Fisher, et al. 2011). Such modifications can be very costly, running into the millions of dollars. For nuclear plants, lowering or extending intake pipes may even require Nuclear Regulatory Commission review (Weiss 2008). Water intake pipes for thermoelectric generators can be up to 18 feet in diameter and extend for long distances. In Wyoming, drought conditions in 2007 – 2008 forced the Laramie River Station, a three-unit, 1,682 MW coal-fired generating station, to not only purchase groundwater rights from local landowners, but also to install 17 miles of pipeline to deliver water to the power plant (Heartland Consumers Power District 2008).

Yet even the extreme measures taken by power plants to continue operating during periods of water shortages may have limited effectiveness if water is simply not available. "If water levels get to a certain point, we'll have to power it down or go off line," said a representative for the operator of the Summer nuclear plant outside Columbia, South Carolina (Weiss 2008).



New plants, too, may face high water procurement costs. In February 2006, Diné Power Authority reached an agreement with the Navajo Nation to pay \$1,000 per acre foot<sup>17</sup> per year for 4,500 acre-feet of groundwater and a guaranteed minimum total of \$3 million for water for its proposed Desert Rock Energy Project (Zah 2006). In Utah, the proposed Blue Castle nuclear plant has agreed to pay \$1.8 million to lease water from the San Juan River and Lake Powell (O'Donoghue 2011).

All of these costs—whether for water rights, water infrastructure additions, or purchased power during droughts—are typically passed on to consumers via electricity rate increases.

Drought can also impact the availability of water for fuel extraction, particularly natural gas. In 2012, dozens of water withdrawal permits were withdrawn from natural gas drilling operators due to low streamflow levels in the Northeast's Susquehanna River Basin (Susquehanna River Basin Commission 2012). In many regions, natural gas drilling takes place in areas already experiencing high water stress (Freyman and Salmon 2013), increasing the vulnerability of operators to drought.

## **B. Unknown Water Quantity Challenges**

The coming collision between growing water demands and dwindling water supplies brought upon by water-intensive energy technologies and booming population growth paints a dismal picture for our current water consumption path. These challenges are likely to be exacerbated by additional factors that are more difficult to measure or predict, including conflicts between agriculture, cities, and power plants; future regulatory actions; and the impacts of climate change on water availability. These “unknown” challenges are discussed below.

### ***Intersectoral Conflicts and Legal Uncertainty***

Water shortages can pit users in one sector against another, even when users hold water rights to a specified amount of water. In the western United States, surface water rights are typically assigned by prior appropriation, which can be summarized as “first in time, first in right.” During reduced water availability, more junior rights are generally curtailed first. Yet in many cases, the specifics of water rights are only vaguely defined, particularly in the case of groundwater where landowners may be permitted to pump as much water from an aquifer as they can put to beneficial use.<sup>18</sup> Water rights may also be over-allocated due to the difficulty of determining what constitutes “normal” river flows or the quantity of water held in a particular aquifer. The Colorado River offers a famous example of rights issued on the basis of higher-than-average water levels, leading to protracted disagreements among users once water levels returned to normal. In addition, legal

---

<sup>17</sup> An acre foot is enough water to cover one acre with a depth of one foot of water; it is equal to about 326,000 gallons.

<sup>18</sup> For example, the “rule of capture” allows landowners to pump as much water from an aquifer beneath their land as they can like, without liability for harm to surrounding landowner wells. The “American rule” or “reasonable use” doctrine limits withdrawals to what can be used for reasonable and beneficial purposes, in view of the similar rights of his or her neighbors, and limits the export of groundwater to other locations if such withdrawal would interfere unreasonably with the groundwater use by neighboring landowners.

water rights often fail to specify the timing of the flows and the characteristics of the water, all of which become of great importance when water becomes scarce.

Legal battles over water rights held by power plants vs. other users have occurred, particularly in western states. Many of these conflicts occur due to the lack of specificity in water rights as well as inadequate supplies of water to serve all users. For example, in 2004 the South Texas Project power plant challenged the water withdrawals of a proposed San Antonio Water System project, claiming that the San Antonio Water System's additional water withdrawals for municipal use would reduce the fresh water available to the power plant. Owners of the South Texas Project protested, even though the power plant would still receive the same total water quantity, because some of the water would be brackish. The legal fight ensued due to the ambiguity of the initial water rights, which did not clarify the characteristics of the water in question (Caputo and Price 2009).

In areas of water scarcity, proposed power plants may find it difficult to obtain legal rights to the water they need. Even the proposed Desert Rock Energy Project in New Mexico, which would use approximately 80 percent less water than a typical coal-fired power plant, faced significant opposition from Navajo ranchers that depend on water to raise livestock and who argued that the Navajo Nation could not afford to lease water to outside companies during times of drought. As a spokesperson for the energy company noted, "Water resources are like gold in the Southwest and the Four Corners region. One of the big sticking points always with other power plants in the region has been water, water, water" (Bryan 2006).

More recently, lawsuits were filed in Salt Lake City by groups protesting the Utah state engineer's decision to grant 53,600 acre-feet of water to a proposed twin-reactor nuclear power plant along the Green River (O'Donoghue 2012). Such legal battles may extend for years prior to resolution, jeopardizing the timely construction of new generation capacity. To remedy this, some states, such as Texas, now require new generators to provide proof of water rights before the system operator will include them in their future planning models (Pickrell 2013).

Thermoelectric generators may face substantial uncertainty regarding their water rights during droughts, even when in possession of well-defined senior rights that give the power plant priority over farmers and users with lesser rights. This uncertainty arises because regulators can implement cuts across the board to senior rights during periods of extreme drought (Caputo and Price 2009), or even reallocate water across sectors. Such reallocations may stem from a lack of well-defined water rights assignments, or through a shift in what is deemed most socially beneficial. The North American Electric Reliability Corporation estimates that 9,000 MW of electric generation capacity is "at risk of curtailment if their water rights are recalled to allow the available water to be used for other purposes" (NERC 2011, 29).

### ***Future Regulatory Actions***

The electric power sector must comply with numerous state and federal regulations regarding water withdrawal, use, and discharge. Among the most significant regulations facing the industry in the near-term is Section 316(b) of the Clean Water Act, governing cooling water intake structures. The regulation is primarily designed to protect aquatic life from inadvertently being killed by intake structures. Section 316(b) requires that the "location, design, construction and

capacity of cooling water intake structures reflect the best technology available for minimizing adverse environmental impact.” Under the regulation, most new power plants must use closed-loop, recirculating cooling systems or dry (air-cooled) systems. While this rule may reduce water withdrawals, water consumption by the electric power sector is expected to increase substantially due to the higher consumption rates of closed-loop systems due to evaporation (NETL 2010).

In 2011, following extensive pressure and litigation from environmental groups, the EPA proposed regulations for cooling water systems at existing facilities that withdraw at least 2 million gallons per day of cooling water (77 Fed. Reg. 34315 (June 11, 2012)). The rule would apply to more than 1,200 sources—more than half of which are existing power plants—and would allow the facility and the local permitting authority to determine what, if any, controls are required to minimize water withdrawals that lead to significant fish kills.<sup>19</sup> The final rule is expected to be released in June of 2013, and may significantly impact the withdrawal and consumption rates of the nation’s fleet of existing power plants. While recirculating systems would reduce fish kills and lower the amount of water withdrawn, water consumption rates would increase, reducing the amount of water available to other users.

### ***Climate Change: The Known Unknown***

Climate change is paradoxically an area of both well-established and ominous certainty in the larger, long-run picture, and great uncertainty about short-run and regional impacts.<sup>20</sup> We know beyond any reasonable doubt that the accumulation of carbon dioxide and other heat-trapping gases in the atmosphere, primarily resulting from fossil fuel combustion, is raising average temperatures, melting ice sheets, and increasing the acidification of the oceans, to mention just a few of the troubling effects. These impacts are pushing the global climate outside the range of historical experience. Extreme weather events are becoming more frequent and extreme; weather-related crop failures are appearing around the world. Threats of irreversible, catastrophic changes, such as many meters of sea-level rise, are still thought to be unlikely, but are becoming steadily more likely as the air warms and the ice melts.

At the same time, the massive research effort devoted to climate change has led to a humbling understanding of the difficulties of precise prediction. The global climate is a massively interconnected, nonlinear system, with complex dynamic responses that cannot be deduced from first principles. State-of-the-art global climate models currently offer more precision in their temperature predictions, and less for precipitation. Moreover, predictions at smaller geographical scales are, perhaps inevitably, subject to more uncertainty. Expected global outcomes are more certain than continental predictions, which in turn are more certain than regional or watershed-level impacts.

---

<sup>19</sup> Environmental and conservation groups have expressed significant concerns that the proposed rule allows far too much flexibility and delegates decision making to state and local authorities, who often lack the resources to fully evaluate controls. See, for example, “Dead Fish, Fouled Water, EPA Misses Opportunity to Fix Power Plant Damage” NRDC, March 28, 2011, available at: <http://www.nrdc.org/media/2011/110328.asp>.

<sup>20</sup> This overview of climate science is supported by sources too numerous to cite here; for a review of recent research literature, see Ackerman and Stanton (2013).

Despite these uncertainties, it remains clear that climate change is happening; if unchecked, it will make the planet less and less hospitable to human society and survival. Policy directed toward reducing emissions to slow future climate change, and toward adaptation to the now-inevitable damages from the early stages of warming, will be essential. Our energy system presents a key opportunity for both mitigating climate change and adapting to the risks of an altered climate through shifting away from carbon- and water-intensive technologies.

### **Climate Change and Water Availability**

Climate change impacts on water resources are difficult to predict on a small scale, but it is clear that climate change will significantly affect water resources in the United States. General impacts relevant to power production will likely include:

- Substantial shifts in where and how precipitation will occur, with certain regions, especially the Mountain West and Southwest, expected to become more arid and experience less runoff (see Figure 9 below) (U.S. Global Change Research Program 2009).
- Precipitation will likely become less frequent but more intense, with heavy downpours increasing and greater precipitation falling in the form of rain as opposed to snow, thus decreasing mountain snowpack and runoff, while making stream flows more intense and more variable (U.S. Global Change Research Program 2009).
- Seasonal flows in rivers will become more erratic and experience shifts in timing of high and low flows, with likely reductions in flows during the summer months (U.S. Global Change Research Program 2009).
- Hotter temperatures will increase electricity use due to higher air conditioning loads, while causing power plants to operate less efficiently and require more water for cooling (Wilbanks 2008).

**Figure 9. Percentage Change in Annual Runoff by 2041-2060 relative to 1900-1970 under the SRES A1B Emissions Scenario**

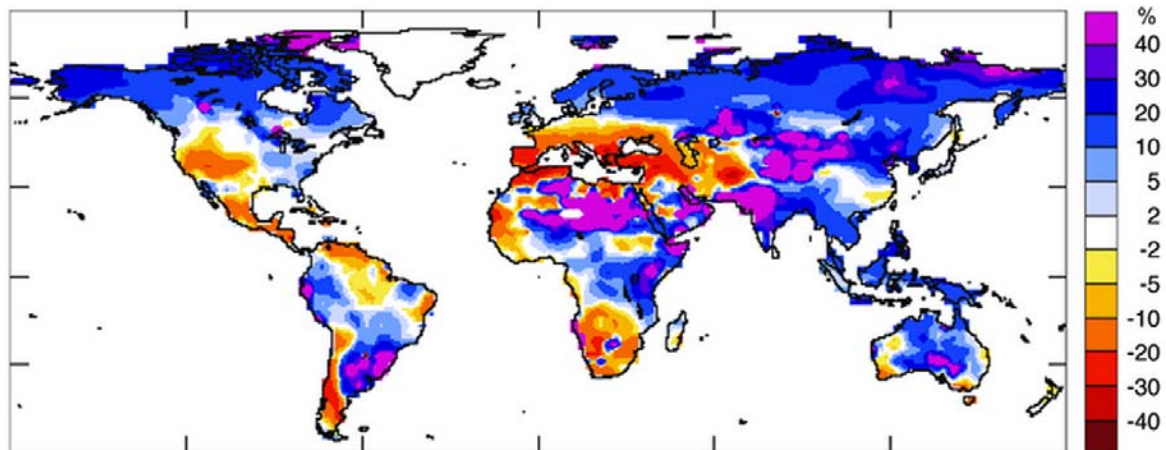

Note: Based on the aggregation of 12 climate models. Source: IPCC  
[http://www.ipcc.ch/publications\\_and\\_data/ar4/wg2/en/ch3s3-4.html#3-4-1](http://www.ipcc.ch/publications_and_data/ar4/wg2/en/ch3s3-4.html#3-4-1)

The U.S. Global Change Research Program reports that over the past 50 years, western snowpack has declined significantly, especially in the Northwest and California, due to rising temperatures. Snow-melt in these areas now occurs up to 20 days earlier, with the expectation that this trend will continue, leading to high river flows—and peak power production—earlier in the spring, with lower flows in the summer (U.S. Global Change Research Program 2009). This timing shift implies that when loads are highest—during hot summer days—less energy will be available from hydroelectric plants, as well as from thermoelectric plants that rely on adequate river flows for cooling purposes.

All of these impacts will increase stress on electric grids that are heavily reliant on thermoelectric power and hydroelectricity, particularly in western regions, but also for eastern regions that may experience droughts and heat waves with greater frequency. Localized impacts remain difficult to predict with precision, increasing the uncertainty surrounding future surface and groundwater availability and highlighting the risks associated with continued reliance on water-intensive energy technologies.

## 3. Energy's Impacts on Water Quality

### A. Known Water Quality Challenges

#### ***Coal Mining***

Coal-fired electricity generation creates myriad health and environmental hazards—including air, land, and water impacts—throughout its lifecycle. Mining, transporting, processing, and burning of coal, along with coal ash disposal, are important causes of human and ecological harms.

#### **Contamination of Water Supplies**

Chemicals released into water supplies by coal operations include ammonia, sulfur, sulfate, nitrates, nitric acid, tars, oils, fluorides, chlorides, sodium, iron, and cyanide, among others (Epstein, et al. 2011).

Elevated levels of arsenic and other heavy metals have been found in drinking water in coal mining areas, often exceeding safe drinking water standards (Epstein, et al. 2011). A study of 223 streams in southern West Virginia found that the cumulative extent of surface mining<sup>21</sup> within their catchment areas is highly correlated with sulfate concentrations and ionic strength in the streams; in the more heavily mined areas, streams also had less diverse populations of aquatic life. These effects extended far downstream from the mining areas (Bernhardt, et al. 2012).

Surface mining gives rise to water pollution when coal with high sulfur content and other impurities is exposed to air and water. The result is runoff containing sulfate, calcium, and magnesium ions, among many other impurities. Since most Central Appalachian coal is washed to reduce its sulfur content, surface mining creates large, polluted slurry ponds, either on site or at a central facility. Even after attempts at reclamation, regional hydrology is profoundly altered, with peak water flows increased in proportion to the extent of mining; this occurs because earth-moving equipment compacts the soil, reducing porosity and water infiltration (Bernhard and Palmer 2011).

#### **Conductivity**

Mine drainage can also raise conductivity, a measure of the ability of water to pass an electrical current; some fish and other aquatic organisms cannot tolerate high levels of conductivity. Informally, conductivity is sometimes referred to as a measure of salinity, although it can result from the presence of many electrically charged ions, either positive or negative, in the water.

A study of water quality in the Upper Mud River and its tributaries in West Virginia found that conductivity and concentrations of selenium, sulfate, magnesium and other pollutants were directly proportional to the upstream area of surface mining; some mines reclaimed nearly 20 years earlier continued to contribute significantly to water quality degradation (Lindberg, et al. 2011).

---

<sup>21</sup> "Surface mining" includes older forms of strip mining as well as the newer practice of mountaintop removal mining; surface mining is typically contrasted to underground mining. Studies of long-term impacts of surface mining, such as those cited here, may include mining done before the era of mountaintop removal.

### **Effects on Human Health**

Coal mining and water pollution have significant effects on human health. A nationwide study, using county-level data, found strong correlations between high levels of coal mining in a county and the county's total, cancer, and respiratory mortality rates; the number of water pollution point sources<sup>22</sup> was strongly correlated with total and cancer mortality (Hendryx, Fedorko and Halverson 2010). These correlations remained significant when controlled for rural versus urban locations and many other potentially confounding effects.

Three major studies, using similar methodologies, have identified human health effects that are correlated with mountaintop removal mining (in addition to the studies of coal mining in general, cited above). One found that chronic cardiovascular disease mortality rates are higher among residents of mountaintop removal counties compared to other counties in the same Appalachian states; this remained true after controlling for other factors associated with cardiovascular mortality, such as higher obesity and poverty rates and lower educational achievement (Esch and Hendryx 2011). Another found higher levels of birth defects in mountaintop mining counties, again compared to other counties in the same Central Appalachian states; the effect was not large (birth defects were 1.26 times as common in mountaintop mining areas as in non-mining counties), but was statistically significant at the 95 percent level (Ahern, et al. 2011). A third study compared health-related quality of life of residents in mountaintop mining counties and other areas. Residents of mountaintop mining counties experienced significantly more days of poor physical health, poor mental health, limited activity, and poorer self-rated overall health, compared with those in other coal mining counties as well as non-mining counties (Zullig and Hendryx 2011).

As these studies emphasize, correlation does not prove causation; none of the health studies have identified specific mechanisms or modes of action by which mountaintop mining and its effects on water quality (or air quality) might cause severe health problems. The strength of the correlations, across multiple health problems, however, suggests that there are serious questions to be addressed—and that stronger regulation of mining practices is a priority for public policy.

### **Ecological Harm**

A number of studies have documented the harmful effects of mountaintop removal mining—a destructive practice that has become common in many parts of Appalachia (Figure 10). The top 50 – 200 meters of a mountain is first clearcut, then dynamited and scraped off to expose the coal underneath; the overburden is dumped into nearby valleys, often burying streams under tens to hundreds of meters of debris (Figure 11). A 2011 study found that more than 1.1 million hectares of Appalachian forest have been converted to surface mines, burying more than 2,000 km of

---

<sup>22</sup> Defined as the number of NPDES permit-holding facilities.



Figure 10. Mountaintop removal coal mining: the Twilight Mine complex<sup>23</sup> in West Virginia. (Photo courtesy of Vivian Stockman / [www.ohvec.org](http://www.ohvec.org); flyover courtesy of Southwings.org.)



Figure 11. A valley fill in progress. (Photo courtesy of Vivian Stockman / [www.ohvec.org](http://www.ohvec.org))

---

<sup>23</sup> The forested hillock at left is a family cemetery. To gain access, the family has to receive written permission from the coal company, be accompanied by guards, and promise not to take pictures.



streams under mining overburden (Bernhard and Palmer 2011). This has had a devastating effect on freshwater habitats in the region, which formerly supported a high level of biodiversity.

### **Uranium Mining and Milling**

Every stage of the nuclear fuel cycle—mining and processing uranium, use of it in nuclear reactors to generate electricity, and disposal of spent fuel and other wastes—carries risks of harm to water supplies. Uranium mining and milling create vast quantities of tailings; runoff from these tailings can contaminate both surface and groundwater. Contaminants include not only uranium and other radioactive materials, but also toxic heavy metals, often found together with uranium. Additionally, the high sulfide content in many tailings may lead to acidification of groundwater. Active remediation of contaminated groundwater has been required at some uranium mining sites, such as Tuba City, Arizona (Abdelouas 2006).

The United States was an important producer of uranium from the 1950s through the early 1980s, reaching an all-time peak in 1980. But domestic output then dropped rapidly as prices fell during the 1980s; today, only a few U.S. mines remain active, and almost all uranium used by reactors is imported (Figure 12).<sup>24</sup> Most of the world’s uranium output now comes from Kazakhstan, Canada, Australia, Namibia, Niger, and Russia, so new mining and milling impacts currently occur predominantly in those countries (National Research Council 2012).

Figure 12. U.S. Uranium Production and Imports

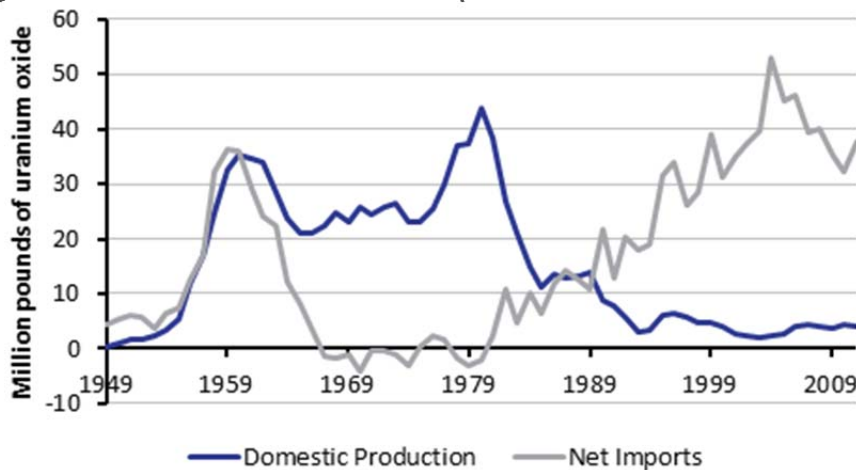

Source: Calculated from EIA, *Annual Energy Outlook 2012*, Table 9.3, <http://www.eia.gov/totalenergy/data/annual/xls/stb0903.xls>, downloaded March 26, 2013.

There are, nonetheless, two reasons for concern about impacts on U.S. water quality from uranium mining and milling. First, the recent increase in uranium prices has led to renewed interest in mining. For example, proposals for uranium mining in southwestern Virginia, the subject

<sup>24</sup> In 2010, roughly 15 percent of world uranium supplies for nuclear power came from military and other inventories, dismantling of nuclear warheads, and re-enrichment of depleted tailings and spent fuel (Nuclear Energy Agency 2012). This source of supply is expected to be largely exhausted within a few years, increasing the future demand for uranium mining.

of longstanding debate in that state, now look increasingly profitable. Both an in-depth report by the National Research Council (National Research Council 2012) and an independent legal analysis (Fiske 2012) have concluded that if Virginia lifts its current moratorium on uranium mining, significant improvements in the existing regulatory structure will be needed in order to protect human health and the environment.

Second, if the domestic uranium industry were to revive, it is important to consider that radioactive and other toxic impacts of uranium mine and mill tailings are extremely long-lasting; improper disposal and handling in the past continue to cause harm in the present. U.S. uranium mining, in its heyday, was concentrated on the Colorado Plateau, including parts of New Mexico, Utah, Colorado, and Arizona. The Navajo Nation, which falls within that region, was heavily affected, and its lands still contain an estimated 1,000 abandoned and partially unreclaimed uranium mining sites; of the 10,000 miners who worked in the U.S. uranium industry, about 3,000 were Navajos (Panikkar and Brugge 2007). Hazards associated with uranium mining had been discussed since about 1930, and were well established by research in the early 1950s, yet little was done until decades later to inform Navajo miners and communities of the risks they faced, or to provide compensation for past harms (Brugge and Goble 2002).

In 1979, the year of the Three Mile Island nuclear accident, an even larger but less publicized accidental release of radioactivity occurred at United Nuclear Corporation's Church Rock uranium mine and mill near Gallup, New Mexico (Brugge, deLemos and Bui 2007). Church Rock, a Navajo town, was the site of the largest underground uranium mine in the United States. Liquid and wet sand wastes from the ore extraction process were released into lagoons, surrounded by earthen dams and impoundments. Early on July 16, 1979, a 6-meter-wide breach in an earthen dam released 1,100 tons of radioactive waste and 95 million gallons of effluent into the nearby Puerco River; the estimated total release of radioactivity was more than three times the amount at Three Mile Island. Residents of the Church Rock area, almost all of them Navajos, used the Puerco River for watering livestock, irrigation, and children's recreation. There were no documented human health impacts, but sheep and goats that drank from the river had elevated levels of radiation in their tissues; a number of contaminated wells were closed and replaced by new wells.

Less than two weeks after the spill, United Nuclear Corporation was allowed to resume operation, discharging waste and effluent into unlined ponds—a process that led to widespread groundwater contamination, and to Church Rock Mill being placed on EPA's National Priorities (Superfund) List in 1983. Meanwhile, the mill was closed in 1982 due to depressed uranium market conditions, and has never reopened (Brugge, deLemos and Bui 2007). Today, 34 years after the spill and 30 years after Church Rock was designated a Superfund site, EPA reports that cleanup activities at the site are completed, human health exposures are under control, but migration of contaminated groundwater is *not* under control.<sup>25</sup>

---

<sup>25</sup> "Superfund Information Systems - Site Progress Profile: United Nuclear Corp.", <http://cumulis.epa.gov/supercpad/cursites/csinfo.cfm?id=0600819>, accessed March 27, 2013.

## Natural Gas Production

The Energy Information Administration's *Annual Energy Outlook 2012* projects that domestic natural gas production will increase by over 29 percent—from 21.6 trillion cubic feet in 2010 to 27.9 trillion cubic feet by 2035. Almost all of this increase is due to the anticipated growth in shale gas production, which is predicted to grow from 5 trillion cubic feet in 2010 to 13.6 trillion cubic feet in 2035 (U.S. Energy Information Administration 2012).

Figure 13. Natural Gas Projections 2010-2035

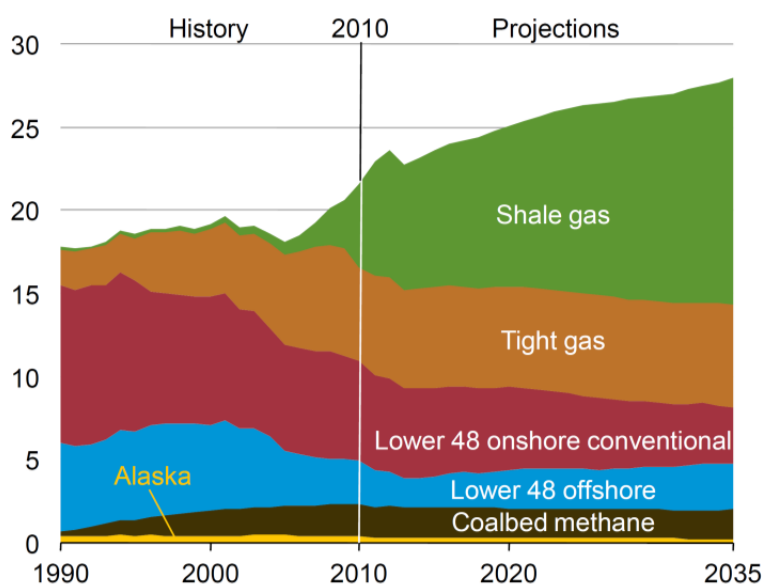

Source: EIA (2012)

Fracking is commonly used to facilitate production of shale gas, tight gas, and coalbed methane, as well as oil. As detailed in Section 2, extracting natural gas via fracking requires significant quantities of water, which is mixed with sand and chemicals and injected deep underground to fracture rock formations and release trapped gas. Natural gas production also involves many known risks to ground- and surface-water quality during every stage of production, including drilling the well, fracking, completion, and wastewater disposal.

### Drilling and Water Contamination

When preparing to extract natural gas, one must first drill the well. A well is drilled using specially concocted drilling fluid, or “drillers’ mud.” This fluid lubricates the drill bit, keeps the well bore from collapsing, and assists in the removal of cuttings—the soil, rock, and other subterranean matter displaced by the drill. The drillers’ mud consists of materials that are solid when still and fluid when agitated, which helps keep the drill cuttings suspended. This mud is carefully monitored as the well gets deeper, and sometimes chemicals like barium will be added to maintain the proper chemistry and density of the mud.

On-site mud pits are dug to contain the mixed mud and also act as settling ponds for the drill cuttings that are extracted from the well. The mud may be reused at another well site, but the

cuttings from the well are typically disposed of in the pits, which can be subject to leakage and overflow and the contamination of local surface waters. These cuttings can contain naturally occurring radioactive materials, heavy metals, and other potentially harmful components (Andrews, et al. 2009).

As the well is being drilled, protective casings are cemented in place both to protect the bore hole from collapse and to protect surrounding aquifers from infiltration of fluids used in the drilling or fracking process or from the escape of methane that will be extracted (Andrews, et al. 2009). If these protective casings are not installed and maintained properly, groundwater aquifers may be at risk of contamination.

### **Methane and Fracking Fluid Migration into Groundwater**

Once the well is drilled and the protective casings are in place, the well is “fracked” to release the gas that is trapped in the formations below. During fracking, a large amount of fracking fluid—water mixed with sand and a proprietary chemical brew—is injected at very high pressure into the well, causing fractures in the shale rock that can extend thousands of feet along the shale formation. In shallow formations, these fractures can create pathways for the migration of methane or fracking fluid into overlying aquifers.

Scientists from Duke University released a report in 2011 documenting what they called “systematic evidence for methane contamination of drinking water wells associated with shale gas extraction” in the Marcellus and Utica shale formations in Pennsylvania and New York (Osborn, et al. 2011). In another study from Duke University, researchers found geochemical evidence for possible natural migration of brine from deep in the Marcellus Shale formation upward to shallow aquifers in Pennsylvania (Warner, et al 2012). These findings suggest that, at least in the Marcellus Shale, natural pathways may exist that would allow fluids injected into deep shale formations to make their way into groundwater supplies.

Faulty well construction can also lead to migration of gas from wells into groundwater. A 2013 study of violations issued by the Pennsylvania Department of Environmental Protection (DEP) revealed that approximately three percent of unconventional gas wells were issued notices of violation for well construction problems (such as casing or cementing incidents). A small number of notices were also issued regarding the violation of the regulation that the “operator shall prevent gas and other fluids from lower formations from entering fresh groundwater” (Vidic, et al. 2013). A previous study of Pennsylvania wells tallied nine different violation codes as well as inspector comments related to improper construction, and found that a much higher percentage of wells—6 to 7 percent—exhibited features of compromised structural integrity (Ingraffea 2012). While the methodologies and results of these studies differ slightly, they both indicate that methane contamination of groundwater is occurring.

When methane migrates into domestic wells in large amounts, it can have tragic consequences. For example, in 2007, after one home exploded and 19 others had to be evacuated, the Ohio Department of Natural Resources determined that migration of natural gas from a fracked well caused gas to invade the overlying aquifers. The gas was then discharged through local water wells, ultimately leading to the conditions that caused the explosion (Ohio DNR 2008).

Seepage of fracking fluids into groundwater is less well-documented, but has also been known to occur. The percentage of fracking water recovered as “flowback water” varies from well to well, averaging 10 percent in Pennsylvania. The fracking fluid that does not resurface with the flowback water may eventually contaminate groundwater. Paths of contamination include abandoned and improperly plugged oil and gas wells, through inadequately sealed spaces between the wellbore and casing, or through natural or induced fractures in the rock (Vidic, et al. 2013).

In a 1987 report to Congress, EPA concluded that hydraulic fracturing can contaminate drinking water and cited a case in West Virginia where fracking fluids were found in a private water well located 1,000 feet from the gas well (EPA 1987).<sup>26</sup> In Wyoming’s Sublette County, the U.S. Bureau of Land Management found that several drinking water wells were contaminated with benzene at concentrations up to 1,500 times a safe level (Lustgarten 2008). Sublette County is home to one of the largest natural gas fields in the country.

More recently the EPA reported—and in 2012 the U.S. Geological Survey confirmed—that fracking fluids had leaked into water in Pavillion, Wyoming. EPA found that wells in the rural town of Pavillion were contaminated with chemicals commonly used in fracking fluid, such as diesel fuel, benzene, toluene, and isopropanol. In addition, fracking, in combination with insufficient casings, likely enhanced the migration of methane from gas wells into nearby drinking water wells (DiGiulio, et al. 2011).

### **Fracking Wastewater**

As discussed above, fracking for natural gas involves the injection of large amounts of water mixed with sand and chemicals into a well. Once the fracking is complete, some of the fluid flows back out from the well and into storage ponds. As the well begins to produce gas, additional water originally present in the surrounding rock formations also surfaces, which is referred to as produced water (Vidic, et al. 2013). A 2009 study estimated that this “produced water” totals 56 million gallons daily from onshore drilling, but actual numbers are undoubtedly much higher, as the estimate was based on 2007 data, prior to much of the expansion in shale gas production (U.S. Government Accountability Office 2012).

Produced water is typically of poor quality, containing both naturally occurring contaminants from the rock as well as added chemicals, and requires treatment prior to reuse. The water may contain:

- Salts such as chlorides, bromides, and sulfides of calcium, magnesium, and sodium;
- Metals such as barium, manganese, iron, and strontium;
- Oil, grease, benzene, and toluene;
- Radioactive materials naturally occurring in the rock;
- Chemicals used in fracking such as friction reducers, biocides, and additives to prevent corrosion (U.S. Government Accountability Office 2012).

---

<sup>26</sup> In that report, EPA cited sealed settlements with landowners as a significant impediment to further investigation of fracking’s impacts on drinking water resources.

Exposure to the contaminants may pose significant risks, including increased risk of cancer, anemia, and increased blood pressure. Further, metals and biocides may threaten wildlife and livestock, while elevated salt levels inhibit crop growth (U.S. Government Accountability Office 2012). Concern over water supply contamination is fueled by the fact that many of the chemicals added for fracking are not currently regulated by the Safe Drinking Water Act. Approximately 750 chemicals and other components were used in fracking from 2005 to 2009, including 29 chemicals that are considered hazardous if found in drinking water (Vidic, et al. 2013). The specific chemicals used and their health impacts are often unknown, as discussed further in section 3.B.

In a recent survey conducted by Resources for the Future, experts from industry, academia, government, and NGOs all identified the storage, treatment, and release of this produced water as a high-priority environmental risk (Krupnick, Gordon and Olmstead 2013). The potential for surface water contamination from fracking activities stems from spills, leaking storage ponds, and insufficient off-site waste treatment.

In 2012, researchers from Stony Brook University released a study detailing the water pollution risks from natural gas fracking (Rozell and Reaven 2012). The risks from wastewater disposal were determined to be the most significant. The authors found that, even in the best-case scenario, wastewater disposal from a single well could potentially release 200 m<sup>3</sup> of contaminated water. This is largely due to insufficient treatment.

Nationally, more than 90 percent of produced water is managed by injecting it into wells that are subject to the Safe Drinking Water Act's Underground Injection Control program. In the Marcellus Shale region, underground injection is generally not available. Instead, fracking wastewater is frequently sent to wastewater treatment facilities where it is treated and then discharged into local surface waters, although reuse is becoming more common. According to Rozell and Reaven (2012), from 2009 to 2010, 77.5 percent of wastewater was sent to approved industrial wastewater treatment facilities, 16 percent was reused in other wells, 5 percent was sent to municipal treatment facilities, 0.5 percent was injected into deep disposal wells, and 1 percent was disposed of in unknown ways. One point of concern is that municipal wastewater treatment facilities are not designed to deal with the contaminants that are found in fracking wastewater. High concentrations of salts and naturally occurring radioactive material cannot be removed by these facilities, and are passed through to local water bodies.

Leaks and spills occurring during transportation of wastewater (either flowback or produced water) to off-site treatment facilities or as a result of mishandling of on-site wastewater are also potential sources of contamination. These incidents are not well monitored and are challenging to predict, though they are likely to happen less often in areas with better regulatory oversight.

### ***Power Plant Waste Disposal***

#### **Flue Gas Desulfurization Wastewater**

Wastewater discharges from power plants currently account for 50 to 60 percent of all toxic pollutants discharged to surface waters by all industrial sources regulated by the EPA (U.S. EPA 2013). Coal-fired power plants produce wastewater through a number of processes, including from pollution controls aimed at reducing emissions of harmful air pollutants. More than half of the

nation's coal-fired electricity is generated by plants equipped with flue-gas desulfurization (FGD) systems, which inject water and chemicals into the flue gas in order to reduce sulfur emissions. However, these systems considerably increase the amount of wastewater produced by a plant; some large plants with FGD systems legally discharge tens of thousands of gallons each day into rivers (Duhigg 2009).

The slurry produced by an FGD system includes high levels of many contaminants, including arsenic, mercury, aluminum, selenium, cadmium, and iron. The precise contaminant composition of the FGD wastewater can vary greatly from plant to plant depending on the coal type, the sorbent used, the materials of construction in the FGD system, how the FGD system is operated, and the other air pollution control systems (if any) operated upstream of the FGD system (U.S. Environmental Protection Agency 2009). Essentially, what is scrubbed out of the flue gas to reduce harmful air emissions will end up in either the solid waste stream or in the FGD wastewater.

In some instances, upstream pollution controls can reduce the contaminants that end up in the FGD wastewater, such as electrostatic precipitators, which remove particulate matter that would otherwise end up in the FGD wastewater. In other cases, however, upstream controls can worsen wastewater contamination. EPA's Office of Research and Development found that controls meant to reduce nitrous oxide (NO<sub>x</sub>) emissions, such as selective catalytic reduction and selective non-catalytic reduction, actually led to increased concentrations of toxic hexavalent chromium in FGD wastes (U.S. Environmental Protection Agency 2009).

Most plants using FGD systems currently discharge their wastewater to settling ponds, which employ gravity to separate particulates from the wastewater. After a certain amount of residence time in the pond, the wastewater is generally discharged to local surface waters. Settling ponds are effective at reducing total suspended solids in the wastewater, as well as other pollutants that are in particulate form, as long as they are given enough time to settle out in the ponds; however, this process is not designed to reduce the amount of dissolved metals in the wastewater. The FGD wastewater entering a settling pond contains significant concentrations of several pollutants in the dissolved phase—including boron, manganese, and selenium—that are then likely to be discharged untreated into the environment (U.S. Environmental Protection Agency 2009).

As regulations on air emissions become more stringent and the use of pollution controls continue to increase, the concentrations and varieties of contaminants in FGD wastewater will likely increase as well. On April 19, 2013, EPA released a draft rule revising the technology-based effluent limitations guidelines and standards for power plants (the first update to the guidelines since 1982).<sup>27</sup> The proposal lays out several options under consideration for new and existing power plants to control discharge of wastewater, and sets the first federal limits on the levels of toxic metals that can be discharged from power plants. One of the options proposed in the rule would require plants greater than 2,000 MW to subject their FGD wastewater to chemical and biological treatment, while those smaller than 2,000 MW would have to use “best professional judgment” to control their effluent.

---

<sup>27</sup> See <http://water.epa.gov/scitech/wastetech/guide/steam-electric/proposed.cfm> (accessed May 23, 2013).

## **Coal Combustion Residuals (CCR)**

Coal-fired plants also produce vast amounts of fly ash, bottom ash, and boiler slag. Along with the solid portion of FGD waste, these byproducts are known as coal combustion residuals (CCR). An estimated 131 million tons of CCR were produced in 2007, of which about 56 million tons were reused for things like cement manufacture, structural fills, and embankments (National Academy of Sciences 2010).<sup>28</sup> CCR that is not recycled remains in a surface impoundment near the plant, or it is dried and landfilled. Typically CCR contains a number of contaminants, including heavy metals and radioactive material (National Academy of Sciences 2010, U.S. Geological Survey 1997).

The potential impacts to water from CCRs include leaching of pollution from impoundments and landfills into groundwater, and structural failures of impoundments leading to spills. Over 670 coal processing waste and CCR sites have been identified by EPA, including both surface impoundments and landfills. Of these, 45 are considered “high hazard” sites (U.S. Environmental Protection Agency 2012). Some of these sites—the most recently constructed—are lined with composite materials, but most of them are either lined with clay or are unlined.

During the past several decades, there have been several documented cases of ground or surface water contamination from coal processing or CCR impoundments (U.S. Environmental Protection Agency 2007). A 2009 report from the Appalachian Voices and the Upper Watauga Riverkeeper found that coal ash ponds at 13 coal-fired power plants in North Carolina were contaminating groundwater with high concentrations of toxic heavy metals and other contaminants (Appalachian Voices 2009). In 2007, a draft risk assessment for EPA found significant human health risks for people living near clay lined and unlined sites from contaminants including arsenic, boron, cadmium, lead, and thallium. The risk pathways identified include “groundwater to drinking water” and “groundwater to surface water to fish consumption” (U.S. Environmental Protection Agency 2007).

To date, CCR has been exempt from federal regulation under the Resource Conservation and Recovery Act (RCRA), which governs solid and hazardous waste; instead, it has been regulated at the state level. In 2010, after an ash impoundment failure at the Tennessee Valley Authority’s Kingston plant released a billion gallons of ash slurry into nearby rivers and covered 300 acres with up to six feet of sludge, the EPA proposed to regulate CCR impoundments for the first time ever under RCRA. The proposal offered two possible approaches to regulating CCR. The first would be to make a determination that CCR is hazardous and regulate it as a special waste under Subtitle C of RCRA. This option would likely require, among other things, the closure and remediation of all surface impoundments like the one that failed in Tennessee. The second option would be to call CCR nonhazardous solid waste and regulate it under Subtitle D of RCRA. Under this option, EPA would determine minimum standards for the disposal of CCR, but ultimately

---

<sup>28</sup> Data that companies report to EIA provides another estimate of annual CCR production. Coal plant operators reported generating from 60 to 260 pounds of waste for each MWh produced (10th and 90th percentile, respectively) in 2008, with an average rate of 135 lbs per MWh. For the same year they reported producing between 11 to 170 lbs of ash waste per MWh from FGD units, with an average rate of 73 lbs per MWh. Applying these average figures to typical U.S. coal-fired generation (1,850 TWhs per year) yields an estimated 114 million metric tons per year of coal ash and 61 million metric tons per year of FGD waste.



states would be in charge of regulating disposal of this waste.<sup>29</sup> The costs to industry if EPA were to finalize the Subtitle C option would be significant—much greater than the Subtitle D option—and industry lobbyists are working hard to ensure that this option is not finalized.

Other examples of catastrophic failures of CCR impoundments include:

- In 1972, an impoundment failed at a mine in Logan County, West Virginia. Approximately 132 million gallons of slurry were released, wiping out a number of small mining towns and contaminating waterways.<sup>30</sup> Known today as the Buffalo Creek Flood, the accident killed 125 people, injured 1,100, and left over 4,000 homeless.
- In October of 2000, a slurry impoundment at a mine near Inez, Kentucky failed, releasing over 300 million gallons of coal sludge into nearby rivers, yards, and croplands. There were no fatalities; however, lawsuits over property damage are ongoing today.

Following the 2008 TVA spill, researchers from Duke University took periodic surface water and sediment samples over 18 months, and measured levels of five contaminants. They found levels of four of the five contaminants to be generally below EPA's "maximum containment level" where there was ample water flow, but higher in areas of restricted flow. Most troubling were elevated levels of a potent form of arsenic (arsenite or As<sub>3+</sub>) throughout the study area, which persisted during the 18-month study period (Ruhl, et al. 2010).

### ***Thermal Pollution from Once-Through Cooling***

As discussed earlier, once-through cooling systems withdraw large quantities of water from rivers, lakes, or other water bodies; use it for cooling; and then discharge it at a much higher temperature. The summer average discharge temperature is 17°F warmer than the water source; hundreds of plants report discharging water above 90°F, and some exceed 110°F—temperatures that are harmful or deadly to bass, trout, and many other species of aquatic life (Averyt, Fisher, et al. 2011).

In a review of scientific literature on temperature and aquatic ecosystems, EPA found that thermal discharges can: alter the populations of phytoplankton; increase the likelihood of algal blooms; accelerate the growth of bacteria; increase mortality of copepods,<sup>31</sup> snails, and crabs; and alter fish habitats, with uncertain results (U.S. Environmental Protection Agency 2011, pp. B1-B4). One study cited by EPA found that there is little or no risk of mortality to salmonids<sup>32</sup> if the maximum annual temperature is less than 26°C (79°F)—but discharges from many power plants routinely exceed that threshold.

An important and well-researched case study resulted from a 2001 permit application by the Brayton Point power plant, a large (1538 MW) coal and oil-burning plant in southeastern Massachusetts. (This account is based on EPA's summary of Brayton Point impacts; see U.S. Environmental Protection Agency 2011, pp. B1-B4.) Once-through cooling at Brayton Point used

---

<sup>29</sup> See 75 Fed. Reg. 35128 (June 10, 2010).

<sup>30</sup> For reference, during the Exxon Valdez oil spill, between 11 and 32 million gallons of oil were released.

<sup>31</sup> Copepods are small crustaceans which are an important food source for many fish.

<sup>32</sup> Salmonids are a family of fish which includes salmon, trout, whitefish, and char.

water from Mount Hope Bay, an ocean bay bordering parts of Massachusetts and Rhode Island. The plant applied for a permit to continue its thermal discharges with a maximum temperature of 95°F, and a maximum departure of 22°F from ambient temperature.

Section 316(a) of the Clean Water Act requires that a power plant's thermal discharge limits "will assure the protection and propagation of a balanced indigenous population of shellfish, fish and wildlife in and on that body of water." EPA determined that Brayton Point's proposed temperature limits—continuing the plant's past temperature limits—would not comply with this standard, for multiple reasons:

- High-temperature discharges favor nuisance algal blooms, one of which had recently occurred at Brayton Point.
- High temperatures also disrupt the normal seasonal progression of phytoplankton, which is a foundation of the existing food webs that flounder and other important fish species depend on.
- Warmer temperatures increase the abundance and overwintering of a ctenophore (comb jelly) species, which consumes both fish eggs and the zooplankton that fish depend on.
- Warmer temperatures and turbidity can prevent the growth of eelgrass, a cold-water plant that is important in forming viable marine habitats in places such as Mount Hope Bay.
- High temperatures can be toxic to the most temperature-sensitive species, such as winter flounder. Stocks of finfish (a category that includes flounder) declined precipitously after Brayton Point Unit 4 switched to once-through cooling in 1984–1985.
- Warm water in the fall and winter attracts large numbers of striped bass, bluefish, and Atlantic menhaden, disrupting their normal seasonal migration and concentrating them in an area with reduced feeding opportunities.

Based on these and other findings, EPA denied the application, and required installation of closed-cycle cooling at all four Brayton Point units in a 2003 decision.

### **Heat Waves and Once-Through Cooling Limitations**

Once-through cooling systems are vulnerable to heat waves: if the incoming river, lake, or ocean water is too warm, it will cool the power plant less efficiently, and the outflow from the plant may exceed the allowable temperature limits for thermal discharge.

In France, where electricity is largely produced by nuclear power, the massive heat wave of 2003 forced shutdowns of several reactors due to cooling water and thermal discharge constraints. The total power loss during that summer was 5,300 GWh, equivalent to more than 200 reactor-days of production. In addition to purchasing power on the wholesale market and negotiating load reductions with industrial customers, the French national electric utility cut its power exports to Italy by more than half. Italy, which normally gets more than a third of its electricity from France, was unable to obtain enough replacement power elsewhere, contributing to blackouts lasting several hours in many Italian cities (Kopytko and Perkins 2011).

In July 2010, as the air temperature reached 98°F in Decatur, Alabama, the Tennessee Valley Authority (TVA) was forced to run its nearby Browns Ferry nuclear plant at only half its capacity.

The Tennessee River, the source of cooling water for Browns Ferry, was approaching 90°F, and Alabama regulations prohibit discharge of water into the river above 90°F. At full capacity, the cooling water would have been heated past the limits for thermal discharge. Browns Ferry was limited to operating at only half its capacity for eight weeks during peak summer temperatures. TVA had to purchase replacement power at a cost of more than \$50 million, all of which was paid by TVA's customers (Kenward 2011).

Such problems are not restricted to one year or one fuel type. To cite just one more example (among many others), Duke Energy had to curtail output at its Allen and Riverbend coal plants in North Carolina in August 2007, because the water in the Catawba River was so warm that the state would not allow thermal discharges that raised the temperature higher. The heat wave coincided with a drought that lowered hydroelectric generation in the region; scattered outages occurred as demand for electricity exceeded the available supply (Beshears 2007).

## **B. Unknown Water Quality Challenges**

Water quality challenges that are poorly understood—due to the complexity of the challenge, and/or limited information—include the potential impacts of climate change, and the health impacts associated with shale gas fracking.

### ***Climate Change and Water Quality***

As climate change warms the atmosphere, and hence surface water bodies, there are likely to be important impacts on water quality. A detailed review by British scientists, focusing on potential impacts in the United Kingdom, concluded that there are many mechanisms by which climate change could affect surface water quality:

“Widely accepted climate change scenarios suggest more frequent droughts in summer, as well as flash-flooding, leading to uncontrolled discharges from urban areas to receiving water courses and estuaries. Invasion by alien species is highly likely, as is migration of species within the UK adapting to changing temperatures and flow regimes. Lower flows, reduced velocities and, hence, higher water residence times in rivers and lakes will enhance the potential for toxic algal blooms and reduce dissolved oxygen levels. Upland streams could experience increased dissolved organic carbon and colour levels, requiring action at water treatment plants to prevent toxic by-products entering public water supplies. Storms that terminate drought periods will flush nutrients from urban and rural areas or generate acid pulses in acidified upland catchments. Policy responses to climate change, such as the growth of bio-fuels or emission controls, will further impact freshwater quality.”  
(Whitehead, et al. 2009, 101)

Attempts to analyze and predict such impacts, however, are fraught with uncertainty (see “Climate Change: The Known Unknown,” in Section 2, above). Hydrological models, seeking to estimate water flows in a river basin under a particular climate scenario, introduce yet another source of uncertainty, leading some scientists to ask, “Are hydrological impact studies of climate change just like throwing a dice?” (Blöschl and Montanari 2010, 378). A task as seemingly simple as

estimating the effects of climate change on lake temperatures involves sophisticated modeling techniques, as seen in a recent study projecting that climate change could raise the surface temperature of Lake Tahoe by as much as 3°C (5.4°F) by the end of this century (Ngai, et al. 2013).

One of the best-studied impacts of climate change on water quality concerns the effects on temperature-sensitive fish species such as salmonids. Warmer temperatures and increases in extreme weather events are expected to reduce suitable habitats, limit growth of individuals, and diminish reproductive success for Atlantic salmon and brown trout (Jonsson and Jonsson 2009), Pacific salmon in Washington (Mantua, Tohver and Hamlet 2010), and four species of trout in the interior western United States (Wenger, et al. 2011).

Warmer water increases the prevalence of some infectious diseases in fish farms, but has no effect on others, and even decreases certain diseases, underscoring the uncertainty of climate impacts on aquatic ecosystems (Karvonen, et al. 2010). A study of environmental vulnerability in benthic (lake or stream bottom) invertebrates in 12 western states found that aquatic species differed widely in their responses to climate, suggesting that climate change could disrupt existing food chains and ecosystem dynamics (Poff, et al. 2010).

### ***Health Impacts of Hydraulic Fracturing***

The unknown (or unpredictable) impacts associated with fracking are vast. First, the fracking fluids that are injected underground to fracture the rock include a mixture of chemical additives. Because underground injections for fracking are exempt from the Safe Drinking Water Act, the precise mix of chemicals used in fracking is often kept secret.

In 2011, a Congressional report from the House Committee on Energy and Commerce found that the top oil and gas production companies used more than 2,500 hydraulic fracturing products containing 750 different chemicals and other components. The chemicals ranged from generally benign substances, such as salt and citric acid, to extremely toxic substances, such as benzene and lead. Many of the fracking fluids contain chemical components that are listed as “proprietary” or “trade secret.” The companies reviewed used millions of gallons of fracking fluids that contained at least one chemical or component that the manufacturers deemed proprietary or a trade secret, and in many instances, the companies were unable to identify these chemicals, suggesting that the companies are injecting fluids containing chemicals that they themselves cannot easily recognize (Committee on Energy and Commerce 2011).

## 4. The Information Gap: Data Needs for Sustainable Energy Planning

As discussed in Sections 2 and 3, many of the challenges associated with the electricity sector's massive demand for (and impact on) water resources are well-understood, whereas in other areas information is woefully lacking. Policymakers require better data regarding the energy-water connection to make informed decisions. This section outlines critical data gaps that need to be filled in order to promote sustainable planning and policy-making for the electricity sector.

### A. Inadequate Power Plant Data Collection and Inaccurate Reporting

Although average water usage by thermoelectric technologies has been studied and documented, plant-level water usage data is of insufficient quality and detail. The Department of Energy (through the Energy Information Administration) has collected self-reported data on water consumption and withdrawals from power plants since 1985 (Averyt, Macknick, et al. 2013). Yet Averyt et al. (2011) estimate that in 2008, power plants responsible for 28 to 30 percent of electric sector freshwater withdrawals did not report their water use to the EIA. Although this data deficiency was due in large part to the exemption of nuclear plants since 2002—an exemption that was recently removed—other power plants failed to report reasonable estimates of water use, specified inaccurate cooling system types, or reported peak water usage rather than annual average rates.

Inaccurate reporting has also resulted from outdated forms that do not describe more advanced cooling technologies. As a result, many plants may not report data consistently or comprehensively, thereby failing to allow cross-plant comparisons (U.S. Government Accountability Office 2009). The EIA recently redesigned its survey on water usage, but data from the new survey is not yet available.

The only centralized source of long-term, national data on water use by sector, including thermoelectric power plants, is provided by the U.S. Geological Survey (USGS) on a five-year basis. These data are essential for water planning, as states are often unable to collect such data themselves. However, there are several problems associated with the USGS data:

- They are compiled from different sources than EIA data.
- The accuracy and methodology of the data can vary, in part because USGS state offices develop water use estimates using different methods (U.S. Government Accountability Office 2009).
- Historically, USGS data have not been made publicly available in a timely manner, with release of the data delayed by up to five years after the date of collection. This reduces the relevancy of the data for water managers and policymakers.
- USGS has decided to discontinue regular reporting of thermoelectric water consumption (in addition to use), and to cease reporting watershed-level water use.

The USGS cites budget constraints and limited staff availability as responsible for data inconsistencies, delays, and its discontinuation of certain reporting. These issues hamper the effective management of water resources by limiting the ability of government agencies and

industry analysts to identify trends in water use and looming intersectoral conflicts (U.S. Government Accountability Office 2009).

On a national level, water availability and use has not been comprehensively assessed in more than 30 years. However, in 2009, Congress moved to remedy this through the SECURE Water Act of 2009, which calls for an assessment (or census) of water availability and use by the USGS. Among the goals of the national water census is the identification of long-term trends in availability and use of water resources—including significant changes in water use due to the development of new energy supplies—and improved ability to forecast water availability for future economic, energy production, and environmental uses.

The USGS has thus far undertaken studies in three large river basins, and plans to assess additional water resources—both surface water and groundwater—on a watershed scale for the census. The SECURE Water Act authorized \$20 million per year for the water census for FY 2009 through 2023, but to date only \$10 million has been appropriated (Alley, et al. 2013). When complete, the water census will do much to address current data gaps. However, it is unclear whether thermoelectric water consumption and watershed-level water use will again be reported at regular intervals, and how current discrepancies in data collection methods will be addressed.

## **B. Uncertainty Associated with Climate Change Impacts**

The inadequacy of information about the impacts of climate change stems primarily from the nature of the climate problem. Despite the massive and ever-expanding body of research on aspects of the climate crisis, crucial questions about the pace of climate change remain uncertain, perhaps inescapably so. The global climate is a complex, nonlinear system, which is now being pushed beyond the range in which human society has developed and thrived. As noted above, climate sensitivity—the long-term pace at which the global average temperature is rising—remains uncertain, and downscaling of global forecasts to regional levels introduces additional uncertainty. The biggest and most ominous climate risks, such as the complete collapse of the Greenland ice sheet (which would eventually cause more than 20 feet of sea-level rise, inundating coastal cities worldwide), are simply outside all relevant experience. While it is clear that warmer air temperatures make ice melt more rapidly, no one knows when the loss of such a massive ice sheet would become irreversible. It is of course infeasible to do experiments on Greenland-sized ice sheets, to learn how fast they melt under controlled conditions.

An additional factor constraining the available information on climate impacts is the vociferous opposition of climate deniers—those who are committed to denying the overwhelming scientific consensus about the reality of the climate threat. The politics of climate denial has limited the collection and dissemination of relevant information, hampering the efforts of those who want to develop timely responses to climate change. At least five state legislatures<sup>33</sup> considered anti-climate-science bills in early 2013. In 2012, under pressure from climate deniers and coastal property owners, the North Carolina legislature abandoned requirements to consider sea-level rise in coastal development planning.

---

<sup>33</sup> The states considering such laws were Arizona, Colorado, Kansas, Montana, and Oklahoma (Branch 2013).

## C. Groundwater Unknowns

The majority of water used by thermoelectric plants is surface water. However, groundwater plays an important role in providing cooling water where surface water is scarce—such as in Arizona, parts of California, and some Midwestern states—and is sometimes used for coal mining and natural gas extraction. Groundwater also provides about 40 percent of the nation’s public water supply and a significant portion of its irrigation water (U.S. Geological Survey 2003).

As additional water supplies are sought to provide water for power plants, coal mines, and natural gas wells, groundwater aquifers will suffer faster rates of depletion and may quickly be exhausted, eliminating water available for all sectors in a region, whether public supply, agriculture, or electricity. The overdraft of aquifers is enabled in part by inadequate monitoring of aquifer levels and inadequate pumping regulations, particularly in regions that adhere to the rule of capture, also called “the law of the biggest pump.”

While numerous observation wells across the nation exist, and water-level monitoring occurs for aquifers within individual states, coordinated monitoring is lacking for aquifers that span state boundaries (U.S. Geological Survey 2003). According to the report *The State of the Nation’s Ecosystems*, groundwater data are “not adequate for national reporting,” due to a lack of standardized approaches at similar spatial or temporal scales for data collection, and uncertainty regarding the long-term viability of data collection efforts (H. John Heinz III Center for Science, Economics, and the Environment 2002).

This absence of a national groundwater-level network with a unified objective and reporting protocols makes interstate groundwater resources exceedingly difficult to manage, thereby precluding accurate assessments of groundwater availability, rates of use, and sustainability (Subcommittee on Ground Water of the Advisory Committee on Water Information 2009). To remedy these issues, the SECURE Water Act (described above) authorized funding of a national Groundwater Monitoring Network. The network is currently in the pilot stage, with plans to move into full implementation in the next few years.

## D. Water Rights Uncertainty

Surface water flows can be highly variable, making it difficult to correctly apportion water rights due to the risk of overestimating water availability. Similarly, groundwater movement, recharge, and the impacts of one user’s pumping on another user’s well are rarely well understood. At the same time, climate change will have indeterminate effects on aquifers, lakes, and streams. All of these factors combine to create ambiguity regarding the security of users’ water rights and the potential for future disputes to disrupt power generation and other activities.

As water shortages loom on the horizon, policymakers need access to the most accurate information available regarding water flows, but also must have the political will to address these issues and renegotiate agreements where necessary. A prime example of this challenge is the Colorado River Compact. As noted above, the Compact allocates shares of the river’s water based on above-average river flows, creating constant risks of shortfalls in average or dry years –

a problem that will only worsen with climate change. The Compact is ambiguous with regard to shortage sharing, and, although a temporary agreement is in place,<sup>34</sup> stakeholders have not agreed upon a long-term solution.

In countless other river basins and aquifers, no agreements are in place to deal with water shortages, or the agreements are vague and subject to interpretation. Lack of comprehensive agreements has already led to protracted legal battles, and will likely lead to many more in the future unless policymakers make the resolution of this issue a priority.

## **E. Inadequate Reporting of Chemicals used in Fracking**

As explained earlier, data on the chemicals used in fracking is often designated as “proprietary” or “trade secret” by gas producers. Because of the 2005 Energy Policy Act exemptions for fracking from the Safe Drinking Water Act and the Clean Air Act and Clean Water Act, it has been difficult for people who believe their health has been impaired by fracking to investigate and prove their cases. Many known toxins and carcinogens are used in fracking, but determining which chemicals are used in any particular well is a challenge.

A few states require some disclosure regarding fracking chemicals; however, more than half of the states with fracking activity currently have no disclosure requirements at all. The Natural Resources Defense Council found that only six states allow disclosure of trade secret information to health care providers who are treating patients exposed to fracking fluid; four of those six states require that doctors sign a confidentiality agreement before receiving the information. The confidentiality agreements generally prevent doctors from sharing the information about the secret chemicals, even with the patient (McFeeley 2012).

## **F. Insufficient Data and Monitoring of FGD Wastewater Treatment Effectiveness**

The effectiveness of treatment systems for FGD wastewater varies widely across the power plant sector. This is partially due to inconsistent definitions of what is considered wastewater across the industry (Higgins, Sandy and Givens 2009). It is also due to the varying levels of treatment systems used. In a report supporting EPA’s recent proposal revising the Effluent Limitations Guidelines and Standards, the Agency found that most coal-fired power plants do not use advanced water treatment systems to treat FGD wastewater (U.S. Environmental Protection Agency 2009). Some state requirements have prompted installation of advanced treatment systems, and many anticipated federal regulations, like the Effluent Guidelines and the CCR rule, will likely drive further improvements in FGD wastewater treatment.

---

<sup>34</sup> In December 2007, the Secretary of the Interior issued interim guidelines for how to allocate the water of the Colorado River. However, the guidelines only extend through 2026 and will need to be revisited then.



## 5. Case Studies

### A. Ohio

The Appalachian Basin, rich in coal and unconventional gas deposits, crosses the eastern portion of Ohio and helps fuel the state's numerous thermoelectric power plants. Ohio ranks third in the country in coal consumption, with many of the state's coal plants lining the banks of the Ohio River along the state's southern border. The waters of Lake Erie hold vast offshore wind potential, but currently the electric sector primarily uses the lake's water for nuclear and coal plant cooling and for transportation of coal.

Coal mining in Ohio began in the early 1800s, followed by oil and gas production starting in the late 1850s; a 20-year oil and gas boom began in 1884. Oil and gas production have never again reached the levels of output of the boom years, but the application of horizontal drilling and hydraulic fracturing to the shale deposits underlying much of the eastern half of the state could significantly increase natural gas production. There has been a recent surge in activity in new well applications, and shale gas production in 2011 far exceeded that of previous years.

The Marcellus Shale is one of the largest natural gas fields in North America, extending from the northern edge of Tennessee into southern New York, and covering parts of eastern Ohio (Figure 14). The EIA estimates the Marcellus Shale contains 141 trillion cubic feet of technically recoverable natural gas reserves (U.S. Energy Information Administration 2012), although some geologists have estimated recoverable reserves of up to 489 trillion cubic feet (Penn State Extension 2012). Both of these estimates far exceed the USGS's 2002 estimate of 2 trillion cubic feet of recoverable natural gas; the dramatic increase is attributable to the rapid deployment of horizontal drilling and hydraulic fracturing.

Utica Shale underlies the Marcellus Shale and reaches into central Ohio, but Utica Shale is less porous, making it more difficult to extract oil and gas. These constraints have precluded much development in the Utica Shale thus far, but that is changing rapidly; production shot up to 2.5 billion cubic feet of natural gas in 2011 (Ohio Department of Natural Resources 2013).

Figure 14. Marcellus and Utica Shale Regions in Ohio



Source: <http://www.epa.state.oh.us/marcellusanduticashale.aspx>

### ***Risky Developments in Natural Gas***

The development of the Marcellus and Utica shale formations has raised concerns regarding the contamination of aquifers—particularly shallow drinking-water systems that many households in the region rely on for drinking water and agricultural use—which are typically unregulated and untested. These concerns are well-founded; recent studies show evidence of methane migration and contamination into these aquifers due to shale gas exploration (Osborn, et al. 2011).

In some cases the contamination has led to severe consequences. In 2007, in a suburb outside of Cleveland, Ohio, Richard and Thelma Payne's home exploded (Lustgarten 2009). Following the explosion, firefighters evacuated 19 other homes due to natural gas intrusions from local water wells. After an extensive investigation, the Ohio Natural Resources Department found that an insufficient well casing at a nearby natural gas fracking site had allowed methane and fracking fluids to escape the well and seep into the local aquifer. Investigators concluded that the methane had migrated up into the homes through the water wells.

Previously, in 2003, the U.S. Department of Health and Human Services had investigated nearby residents' health complaints related to exposure to methane in their bath water, dishwashing, and drinking water. That study found that gas in the area could migrate through underground fractures, and stated that "combustible gases, including methane, in private well water present an urgent public health hazard."<sup>35</sup>

---

<sup>35</sup> See ATSDR Report at: <http://www.atsdr.cdc.gov/hac/pha/pha.asp?docid=631&pg=1>

Ohio is also home to many deep underground injection wells used for wastewater from fracking activities. A recent study estimates that 12.8 million barrels of wastewater were injected into Ohio's underground wells, with more than half of the wastewater originating in Pennsylvania and West Virginia (Lutz, Lewis and Doyle 2013). Scientists believe that these deep wastewater injections caused two earthquakes in the eastern Ohio town of Youngstown—on Christmas and New Year's Eve in 2011.

Management of contaminated wastes and prevention of aquifer contamination from fracking chemicals are key concerns for Ohio. In March 2013, two men were indicted for dumping drilling mud and brine into a stormwater drain in Youngstown, Ohio that empties into the Mahoning River. Tests revealed that the mixture dumped contained several hazardous pollutants including benzene and toluene (Linert 2013). While these incidents may be rare, the spillage or deliberate dumping of toxic waste may have profound long-term consequences on the environment and human health.

Recently some progress has been made in tightening regulations pertaining to fracking in Ohio. In June 2012, the state enacted legislation that requires chemical disclosure during the drilling process and during hydraulic fracturing, while allowing some exceptions for trade secret information. However, the Ohio Department of Natural Resources can request confidential information in response to a spill or to conduct an investigation. In addition, medical personnel are allowed to share even proprietary information with patients and other medical professionals.

Ohio's law also requires pre-drilling water samples and the monitoring and disclosure of baseline water quality in nearby water sources (McFeeley 2012). Additional legislation is proposed that would require drilling companies to test drilling muds, dirt, and rock for radioactivity, and send wastes containing high levels of radioactive material to special disposal sites licensed to handle such material (Smyth 2013). However, a controversial provision would allow the radioactive material to be "down blended" with soil, sawdust, and other materials in order to dilute the radioactive content, and would allow the material to be disposed of in landfills (Downing 2013). Once in the landfill, this dirt could potentially be blown into the air, or the radioactive material could move into the liquids that form in the landfill, which is then collected and taken to wastewater treatment plants that are not equipped to handle such waste. From there, the contaminated water would likely be released into waterways and flow downstream. For these reasons, environmental groups are currently lobbying to prohibit the disposal of radioactive waste in the state's landfills (WVIZ/PBS ideastream 2013).

### **Coal Mining in Ohio**

Water contaminated with coal dust has spilled for the fourth time since 2000 into a Belmont County creek that is home to an endangered salamander, state agencies reported this morning. – *Columbus Dispatch*, October 1, 2010 (Caruso 2010)

Captina Creek is a normally high-quality water body that provides habitat for Ohio's last breeding population of the Eastern Hellbender Salamander (Fisk 2010); it is also in close proximity to Murray Energy's American Century Mine. Slurry (water used to wash newly mined coal) spilled by the Century Mine has repeatedly contaminated the creek and (among other consequences) threatened the survival of the hellbender. A newspaper account of the 2010 spill pointed out that it was not as bad as earlier ones, such as the 2008 spill at the same site (Caruso 2010).

The harmful impacts of the coal industry on Ohio water quality extend far beyond the confines of Captina Creek, as shown by the Ohio Environmental Protection Agency reports on water quality in selected streams and rivers in 2009. In some areas, such as the Sunfish Creek watershed and nearby areas of Monroe and Washington counties, water samples have been of generally acceptable quality, with some problems caused by inadequate sewage treatment (Ohio EPA 2010, Sunfish). In contrast, in the McMahan Creek watershed and selected Ohio River tributaries in Belmont county, some streams have been found to be in non-attainment status due to acid mine drainage from past coal mining, and due to leachate from a landfill (and federal Superfund site) located on top of a previously mined area (Ohio EPA 2010, McMahan). One water sample from this area contained an astonishing 1,890,000 µg/l (roughly 2 parts per 1,000) of iron ore, which turned the water an orange-red color.

Pollution from coal mining diminishes the value of lakes for recreation, making boating, fishing, and swimming less attractive. A study of water quality and recreation in lakes throughout eastern Ohio found that all else being equal, there were fewer visitors at lakes with higher sulfate content, a problem which is known to be caused by mining runoff. For five coal-mining-impacted lakes, sulfate pollution led to a total annual reduction of 670,000 visits—a loss of recreation valued at \$21 million in 2006 dollars (Mishra, et al. 2012).

Legacy effects of past coal mining on surface waters cannot be ignored. Even when former surface mining sites are being or have been reclaimed, harmful effects on water quality continue for years. A study of 30 sites in the Raccoon Creek watershed in southeastern Ohio, most of which are in various stages of reclamation, found that stream conductivity, sulfate, and aluminum levels—but not pH (acidity)—increase in proportion to the area of reclaimed mines in the vicinity. This suggests that remediation projects may be able to regulate watershed acidity levels, but not conductivity and some heavy metal concentrations. Conductivity levels were often high enough to impair aquatic ecosystems (Hopkins, et al. 2013).

Some of the water quality problems created by the history of coal mining are literally out of sight. Abandoned underground mines can have dramatic effects on water flows, reducing surface flow and greatly increasing lateral subsurface flows, as shown by detailed modeling of the Monday Creek watershed in southeastern Ohio (Wan, et al. 2012). These subsurface flows transport increased quantities of sediment, nutrients, and minerals, inevitably spreading acid mine drainage over wider areas. In addition, these underground “quick flows” can contribute to flooding during storms.

### ***Climate Change Impacts in a “Wet” State***

Although a warming climate may bring greater precipitation to Ohio and other Great Lakes states, elevated temperatures are predicted to more than offset this precipitation with higher rates of evaporation, lowering surface water levels in the Great Lakes.<sup>36</sup> Some climate models predict significantly lower water levels in the Great Lakes, with declines up to 4.5 feet (Gregg, et al. 2012),

---

<sup>36</sup> Most of the water in the Great Lakes resulted from the melting of glaciers at the end of the last ice age; annual inflow from precipitation and runoff is less than 1 percent of the volume of water in the lakes (estimated from Lofgren (2004)).

which would dramatically reduce the surface area of Lake Erie, the shallowest of the Great Lakes. River and lake water temperatures will also increase, reducing the efficiency of power plants. As in much of the United States, droughts are projected to become more prevalent, further reducing river flows and lake levels.

Ohio's economy is highly reliant on Lake Erie and Ohio River shipping routes for imports and exports. The state ranks eighth in the nation for total shipping tonnage; in 2008, Lake Erie commerce to or from Ohio—largely iron ore, limestone, and coal—amounted to 40.6 million tons, valued at \$3.6 billion (Ohio Department of Transportation 2013). Ships used on the Great Lakes are designed and loaded to just barely clear the shallowest points on their routes; the Great Lakes Carriers Association reports that a ship can lose 270 tons of carrying capacity for each 1 inch reduction in water levels. Ohio River traffic, an even bigger factor for the state's economy—63 million tons per year, largely coal, worth \$7.4 billion in 2008 (Ohio Department of Transportation 2013)—is also vulnerable to disruption by either drought or floods. A two percent decline in shipping activity would cause the shipping industry to lose more than \$550 million, while the rest of the state economy would lose \$450 million (National Conference of State Legislatures 2008).

More than 98 percent of Ohio's electricity generation comes from thermoelectric plants, with 86 percent from coal and 10 percent from nuclear (U.S. Energy Information Administration 2012b). These power plants primarily rely on Lake Erie and the Ohio River to supply their cooling water, but lower water levels and higher water temperatures could force generators to shut down, as has occurred in recent years throughout the Southeast. In particular, Ohio's two nuclear plants, Davis-Besse, near Toledo, and Perry, near Cleveland, are both located on the shore of Lake Erie, and draw cooling water from the lake. As climate change shrinks Ohio's water resources, the massive water withdrawals by these power plants are likely to become the center of considerable contention.

## B. Colorado

A confluence of factors threatens the sustainability of Colorado's water resources. Population pressures are a real and growing concern, as the state's population is projected to increase by 35 percent over 2000 levels by the year 2030 (U.S. Census Bureau 2005). Water will be needed to not only supply domestic water needs and irrigate agriculture, but also to provide the cooling water for thermoelectric generators to meet the population's growing electricity demands, which are projected to grow by about 17 percent<sup>37</sup> between 2012 and 2035 (U.S. Energy Information Administration 2012). At the same time, Colorado's climate is steadily warming, leading to reduced mountain snowpack and less runoff to feed Colorado's rivers, streams, aquifers, and numerous other water bodies throughout the West (Ray, et al. 2008).

---

<sup>37</sup> The EIA projects electricity generation by electricity market region. Colorado comprises the majority of the Western Electricity Coordinating Council/Rockies (RMPA) region, but small portions of Wyoming, South Dakota, and Nebraska are also included.

Colorado is endowed with significant amounts of fossil fuels, and has traditionally relied heavily on coal and, more recently, natural gas for electricity generation. The state also possesses tremendous oil shale reserves, which, if developed, could require more water than is currently supplied to the Denver metropolitan area and restrict agricultural and urban development in Colorado (Mittal 2011).

This dominance of fossil fuels comes at a cost. Since 1998, the oil and gas industry in Colorado has reported more than 1,073 spills or leaks of chemicals, hydrocarbons, drilling water, or other fluids that have impacted either surface water or groundwater. Meanwhile, mining for coal and natural gas in the state consumes an estimated 4 billion gallons of water per year, and power plants withdraw more than 87 billion gallons, of which 25 billion gallons are consumed and hence unavailable to other sectors.

### ***Mining in Colorado***

Mining has played a formative role throughout Colorado's history, and remains important today. Colorado is ranked 11<sup>th</sup> in the nation in coal production (U.S. Energy Information Administration 2013d). Coal deposits underlie approximately 28 percent of the state, and in 2011, nearly 27 million short tons of coal were produced in the state, requiring nearly 2 billion gallons of water (Colorado Department of Natural Resources 2005, U.S. Energy Information Administration 2013d).<sup>38</sup> Colorado exports approximately two-thirds of its coal to other states and Mexico, with the rest used within Colorado to produce electricity (Burnell, Carroll and Young 2008).

Both natural gas and oil production have grown in recent years. Oil production has more than doubled over the past ten years, while natural gas production has skyrocketed since 1990; the state now ranks fifth in the country in natural gas production (U.S. Energy Information Administration 2013f, U.S. Energy Information Administration 2013d). Natural gas production will likely continue to expand, as the state possesses enormous natural gas reserves, including the country's largest reserves of coalbed methane. One of the largest natural gas pipelines in North America, completed in 2009, runs from Colorado to eastern Ohio, delivering 1.8 billion cubic feet of natural gas per day (Sempra U.S. Gas & Power 2013).

Nearly all of Colorado's natural gas requires fracking to release it. Under current production techniques, this implies that approximately 2 billion gallons of water is consumed for fracking annually<sup>39</sup>—similar to the amount required for coal mining (Colorado Department of Natural Resources 2012).

While the proportion of water used for fracking in Colorado is far less than that used for agriculture, the development of new wells can exacerbate local water shortages and intersectoral

---

<sup>38</sup> Water use based on U.S. Department of Energy (2006) water use factors for underground and surface mines, allocated proportionally to the amount of Colorado's coal mined from each mine type, as reported in Table 1 of the *Annual Coal Report* (<http://www.eia.gov/coal/annual/pdf/table1.pdf>).

<sup>39</sup> According to Mielke, Anadon and Narayanamurti (2010), fracking requires 1.3 gallons per MMBtu on average.

conflicts.<sup>40</sup> A recent study found that 92 percent of the shale gas and tight oil wells in Colorado are located in regions of extremely high water stress. The natural gas industry in Colorado pays a premium to access water for drilling purposes, enabling it to secure water for fracking that previously would have been used for agricultural or municipal purposes (Freyman and Salmon 2013). As natural gas production continues to rise, intersectoral conflicts are likely to intensify.

Figure 15. Oil and Natural Gas Production in Colorado

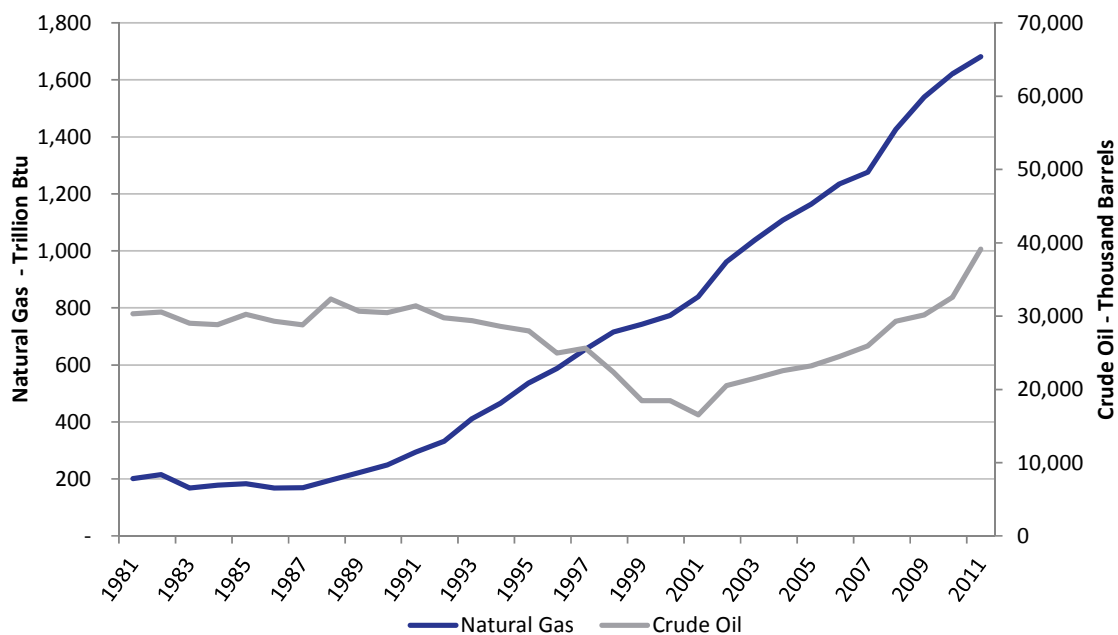

Source: EIA (2013f)

Along with increased oil and natural gas extraction has come increased water contamination: 4,662 spills or releases since 1998 are listed in the Colorado Oil and Gas Conservation Commission’s database, of which 1,073 have impacted either surface water or groundwater (Figure 16). The majority of these spills have been small and quickly cleaned up, but some have occurred over extended time periods and contaminated thousands of gallons of water with toxic chemicals such as benzene and toluene. The substances spilled or released include oil, produced water, and “other” fluids, which may include fracking fluids.

<sup>40</sup> See for example, Jack Healy, “For Farms in the West, Oil Wells are Thirsty Rivals,” *The New York Times*, September 5, 2012.

Figure 16. Oil and Gas Spills in Colorado Affecting Water Bodies

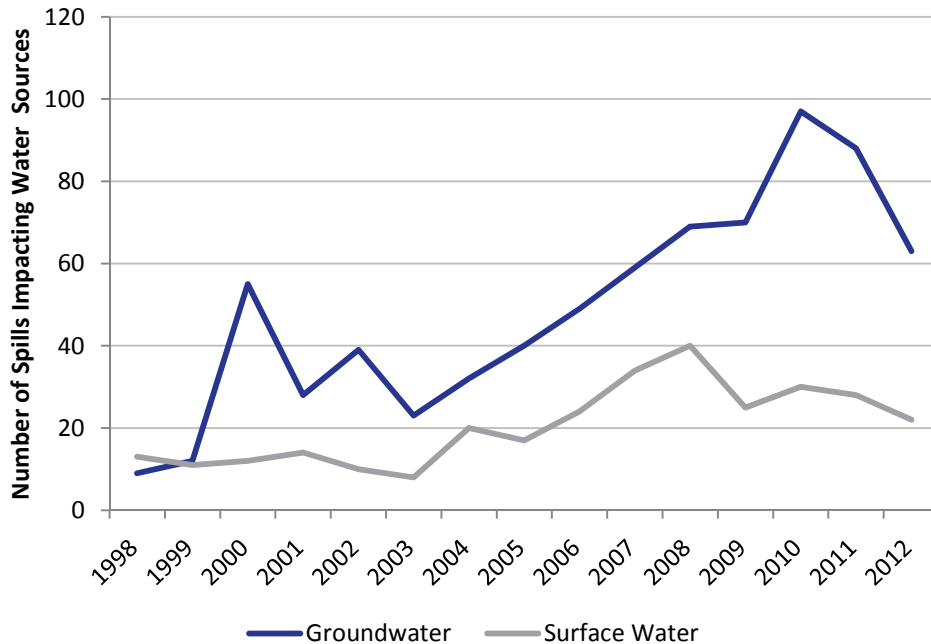

Source: Colorado Oil and Gas Conservation Commission Spill/Release Information <http://cogcc.state.co.us/>

Among the spills reported to the Commission was the 2009 discovery of a hole in the production casing of a well that contaminated the Laramie-Fox Hills Aquifer with produced gas. The discovery came after a nearby resident filed a complaint describing gas bubbles present in his water.<sup>41</sup>

A similar leak, also due to a corrosion hole in the production casing, was discovered when a pipeline was tested in 2011. It is unknown how much fluid seeped into the groundwater, but test results for the carcinogens benzene and toluene exceeded state standards, and 2,760 gallons of affected water were removed to a disposal site (Colorado Oil and Gas Conservation Commission 2011).

More recently, elevated levels of benzene were found in groundwater wells and Parachute Creek in April 2013 following a natural gas liquids leak resulting from a faulty pipeline pressure gauge. It is estimated that 10,000 gallons of natural gas liquids entered the soil and groundwater, of which only 6,000 have been recovered to date. Nearby wells report benzene levels up to 18,000 parts per billion (ppb), greatly exceeding the state health standard of 5 ppb. The irrigation diversion for the town of Parachute lies only 2.7 miles downstream from the leak, and benzene levels in the creek, while much lower than in the wells, are concerning town officials (The Denver Post 2013, Webb 2013).

Other recent spills or leaks reported by the Colorado Oil and Gas Conservation Commission (2011) include:

<sup>41</sup> Colorado Oil and Gas Conservation Commission, Administrative Order by Consent - Order No. IV-349, 2010.



- An overflow of fracking fluids around a well pad that reportedly did not result in water contamination but required the use of a vacuum truck to recover the fluids;
- The release of approximately 100 gallons of fracking fluid onto land due to a broken hydraulic line;
- A leak from an oil tank that contaminated 115 cubic yards of soil and released benzene into shallow groundwater, leading to the removal of about nearly 15,000 gallons of affected groundwater;
- A corrosion hole in a pipeline that led to the release of condensate and natural gas into the Boulder White Rock irrigation canal; and
- A vandalized wellhead valve that released about 48,468 gallons of produced water onto Southern Ute tribal lands.

In less than 2.5 years (between Jan 1, 2008 and June 15, 2010), reported spills have totaled about 5.2 million gallons of fluids and oil, of which more than 3 million gallons have been drilling water—including water used in the fracking process, although it is unclear whether such water contains fracking chemicals (Hubbard 2010).

Although the boom in natural gas has dominated much of the discussion regarding water and energy in Colorado over the past decade, the future development of oil shale could dwarf current water resource impacts. Colorado's oil shale deposits are vast and contain an estimated 1 trillion barrels of oil (U.S. Energy Information Administration 2009). However, this oil is locked in rock which must be heated to between 650 and 1,000 degrees Fahrenheit before it becomes accessible. Such a process would have enormous requirements for both water and energy. A mid-range production scenario for the years 2036-2050 would require an estimated 33 billion gallons of water annually to produce 200,000 barrels of oil per day, including indirect water demands of the mining process (URS Corporation 2008). This is equivalent to eight times the estimated total of water currently consumed by Colorado's coal and natural gas extraction industry.

The water quality impacts of oil shale are unknown, but runoff from the mining operations could contaminate nearby water bodies with sediment, salts, chemicals, and oil shale products. Runoff from spent shale rock (waste rock) is of particular concern, as the runoff could transport salts, selenium, metals, and residual hydrocarbons into nearby streams, and would persist long after mining operations cease (U.S. Government Accountability Office 2010).

### ***Electricity Generation in Colorado***

Colorado is heavily dependent on thermoelectric power plants (particularly coal) for its electricity generation, as shown in the Figure 17.

Figure 17. Electric Generation by Source in Colorado

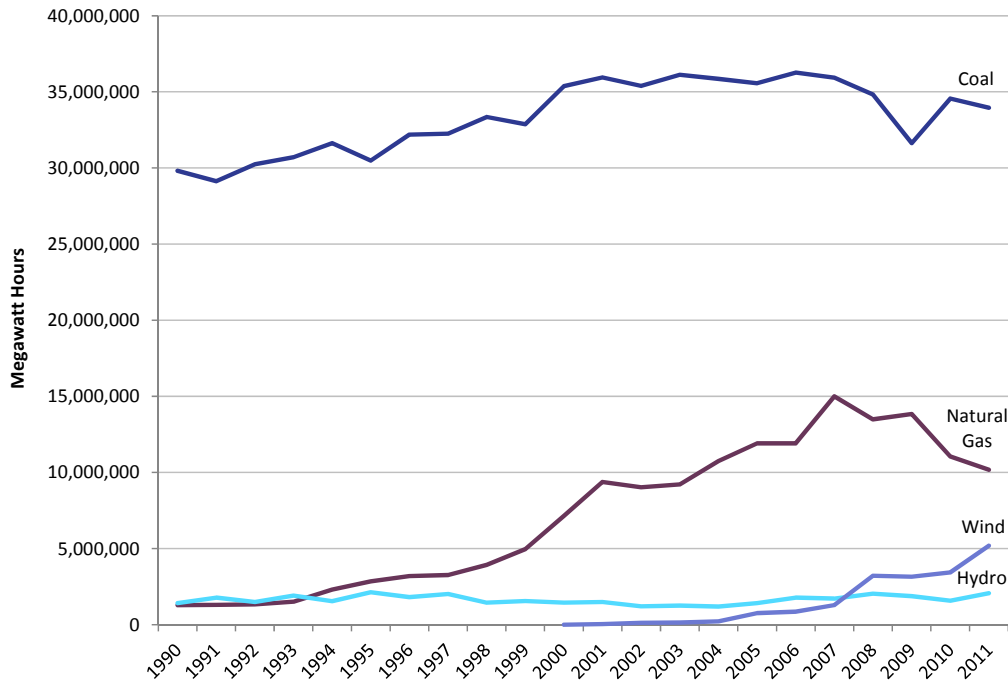

Source: EIA (2012b)

Also shown in Figure 17, Colorado has begun more aggressive development of its renewable resources in recent years, especially wind energy. In 2012, 11 percent of the state’s energy came from wind power, while 4 percent was produced by hydroelectricity. The state’s Renewable Energy Standard cites minimizing water used for electricity generation as a goal, stating that

“in order to save consumers and businesses money, attract new businesses and jobs, promote development of rural economies, minimize water use for electricity generation, diversify Colorado’s energy resources, reduce the impact of volatile fuel prices, and improve the natural environment of the state, it is in the best interests of the citizens of Colorado to develop and utilize renewable energy resources to the maximum practicable extent.”<sup>42</sup>

Under current energy policy, renewable energy in and around Colorado is projected to grow by 72 percent from 2012 to 2035. However, during this same time period, coal power is also expected to grow (albeit slightly), and electricity produced from natural gas is expected to more than double (U.S. Energy Information Administration 2012).

Thus, thermoelectric energy will continue to dominate (and increase) under a business-as-usual approach to energy planning in Colorado. Under such a scenario, using the conservative assumption that new coal plants will use IGCC technology and that natural gas power plants will not be required to add CCS technology, water consumption by power plants could rise by nearly 2

<sup>42</sup> 4 Code of Colorado Regulations (CCR) 723-3, Rules Regulating Electric Utilities, Rule 3604(h).

billion gallons per year, with water withdrawals increasing even more. The use of CCS for natural gas plants and the retrofitting of older coal plants with CCS technology would more than double this additional water consumption.

### ***Climate Change in the Southwest***

Average temperatures in Colorado are expected to rise about 2.5 degrees Fahrenheit by 2025 and 4 degrees by 2050 as a result of climate change. Since the 1970s, warming temperatures have already caused snow to melt earlier in the spring, shifting Colorado's spring pulse (the onset of streamflows from melting snow) earlier by two weeks. This trend is expected to continue, leading to reduced late-summer flows when demand for electricity, and thus also for cooling water and hydroelectric water, is highest.

Of equal concern is that hydrological models suggest that rising temperatures will increase watershed evapotranspiration, reducing runoff for most of Colorado's basins and leading to less surface water available while also decreasing aquifer recharge. Aggregated estimates from multiple models of the Upper Colorado River Basin suggest decreases in runoff ranging from 6 to 20 percent by 2050, although one model estimates that runoff could decline by as much as 45 percent (Ray, et al. 2008).

Higher temperatures will also increase evapotranspiration from plants, including agricultural crops, heightening the need for irrigation water, while the earlier snowmelt reduces summer water availability. Simultaneously, air conditioning loads and electricity demand will rise as people experience warmer weather, but higher ambient air and water temperatures will depress the efficiency of power plants. Droughts and heat waves will magnify these trends, causing intersectoral conflicts and requiring state regulators to revisit, and possibly reallocate, water rights among competing users. Thermoelectric generators may find that their water allocations are reduced as rivers and lakes dry up and there simply is no water to be had. The electric power sector will be forced to compete with urban areas and agriculture to procure additional water supplies, which may need to be piped in over great distances.

Interstate and perhaps international conflict could erupt over diminished flows in the Colorado River, which spans seven states and flows into Mexico. The Colorado River Compact allocated specific quantities of the river's water based on average flows in 1905 to 1922, now widely seen as a period of abnormally high rainfall; shortfalls are common in more "normally" dry years. The river currently provides water to 40 million people and 5.5 million acres of irrigated cropland while also producing hydroelectricity, but climate change is projected to decrease flows by 9 percent on average, with droughts lasting 5 or more years occurring 50 percent of the time over the next 50 years (U.S. Bureau of Reclamation 2012). The resulting gap between the river's water supply and demand is shown in Figure 18.

Figure 18. Colorado River Basin Historical and Future Supply and Demand

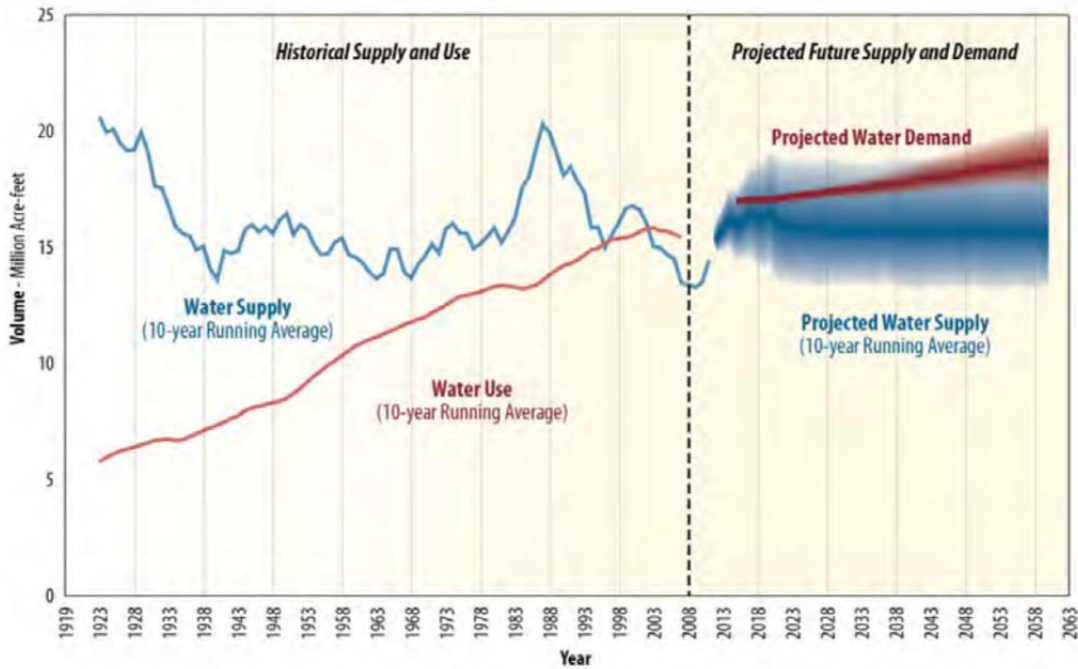

Water use and demand include Mexico's allotment and losses such as those due to reservoir evaporation, native vegetation, and operational inefficiencies. Source: U.S. Bureau of Reclamation (2012).

### Energy-Water Management Initiatives in Colorado

Colorado's ability to meet its future water needs in the face of growing energy demand, declining supplies, and potential water quality degradation from fuel extraction is uncertain, but policymakers in the state are beginning to take actions to address some of these issues. For example:

- Utilities must file resource plans that include the annual water consumption for each of the utility's existing generation resources, the water intensity (gallons per megawatt hour) of the existing generating system as a whole, and the projected water consumption for any resources proposed to be owned by the utility and for any new generic resources included in the utility's modeling for its resource plan.<sup>43</sup>
- Colorado has adopted a Renewable Energy Standard that requires each investor-owned utility to provide renewable energy for 12 percent of its retail electricity sales for the years 2011-2014, followed by 20 percent from renewable sources for the years 2015-2019, and 30 percent thereafter.
- In December 2011, the Colorado Oil and Gas Conservation Commission passed the Hydraulic Fracturing Disclosure Rule, which requires the operator of each well to disclose the chemicals and additives used in the fracking fluid, as well as the concentration of each

<sup>43</sup> 4 Code of Colorado Regulations (CCR) 723-3, Rules Regulating Electric Utilities, Rule 3607(a)(IX).

chemical added. However, companies may claim that a chemical is trade secret, which only requires them to reveal the chemical to health professionals under a medical emergency. In order to discourage companies from using the trade secret protection, Colorado enables reporting of chemicals to be delinked from the additives reported, thus preventing competitors from reverse engineering the formulation of the fracking additive (Moulton and Plagakis 2012).

These actions represent a positive step forward for Colorado's water resources, but they are only a drop in the bucket relative to the magnitude of the challenges Colorado faces. As energy demands soar and droughts parch the state, billions of gallons of water will no longer be available for water-intensive electricity production. Existing thermoelectric plants could be retrofit with dry cooling towers, but the expense and high energy penalty of these designs may make their use impractical. Less water-intensive technologies such as additional wind and solar PV are likely to have the greatest impact on preserving Colorado's water quality and ensuring sufficient quantities of water are available to meet the needs of a growing population and economy, even under climate change.

## 6. Summary and Recommendations

Today's electric power system was built on traditional, water-intensive thermoelectric and hydroelectric generators. The water requirements of this energy system are enormous. Once-through cooling of large power plants withdraws staggeringly large quantities of water from rivers, lakes, and estuaries; it is a luxury that only the wettest areas can afford. Closed-cycle cooling, using cooling towers or ponds, reduces withdrawals but actually increases consumption, via evaporation. In arid regions, even this is a burden on limited water supplies.

Going forward, the traditional abundance of our water resources will decline due to growth in population and municipal water demand, coupled with pressures from industry and agriculture, drought, and climate change. Legal challenges and environmental regulations will increasingly question the massive water withdrawals and consumption levels of coal, nuclear, and natural gas generators, particularly when alternatives that require little water, such as wind and solar, exist.

Extraction and processing of fuels for thermoelectric generation—particularly coal, uranium, and natural gas—threaten to contaminate water resources with toxic chemicals, impacting both ecosystems and human health. Coal mining, today largely surface mining, often involves the extraordinarily damaging processes of mountaintop removal and valley fills, which destroy communities, streams, and ecosystems. Uranium mining, a once and future hazard, creates long-lasting radioactive risks, and has caused extreme damages to miners' and nearby communities' health. Natural gas, with the explosive growth of fracking, has brought us flammable tap water and carcinogenic contamination of groundwater in the unlucky host communities. Yet despite the risks associated with such energy technologies, the EIA expects generation from thermoelectric sources to increase through 2035 under existing energy policies, as shown in Figure 19.

Figure 19. Thermolectric Generation Projections through 2035

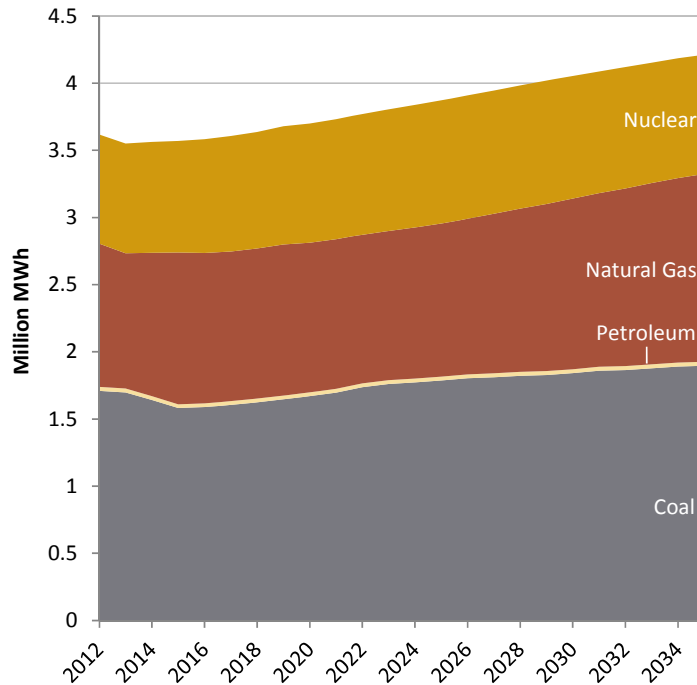

Source: EIA Annual Energy Outlook (2012)

Water constraints are binding in different ways in different regions of the country. In relatively wet areas, such as Ohio, energy production—whether coal mining or fracking—threatens to damage water quality. At the same time, climate change will increasingly cause heat waves, droughts, and declining water levels that may impede shipping (of coal and other commodities) and reduce the efficacy of cooling water intakes. In dry areas, such as Colorado, water scarcity is an immediate and worsening challenge, with mining and electricity generation pitted against growing municipal and agricultural demands for water.

There is much that we don't know about water and energy. Better data are needed in many areas, to map and measure the problems in more detail, as a step toward solutions. Climate change is a crucial source of perhaps irreducible uncertainty, which is only made more difficult by backward-looking political initiatives that are determined to deny and ignore the crisis.

There is also much that we do know—enough to say that a very different approach is needed. Continued investment in water-intensive electric generation technologies puts consumers and regional economies at risk of interruptions in electricity supply or on the hook for costly market power purchases or water infrastructure projects. To ensure a reliable, cost-effective supply of energy, these water-related risks must be fully accounted for in energy planning, regulations, and policies.

At a minimum, we recommend that regulators and policymakers:

- Conduct long-term water resource planning on a regional basis and across sectors. To do so, regulators will need better data regarding the future water needs of growing

populations, as well as the likely impacts of droughts and climate change on water availability.

- Require entities proposing to construct new power plants or retrofit existing plants to conduct water resource adequacy assessments, as well as incorporate the future opportunity cost of water in a power plant's cost estimates. Regulatory approval should be required for water withdrawals and consumption above a certain threshold. Currently, states vary in their regulatory oversight; not all commissions have authority to regulate power plant water use, and therefore do not account for the impacts of a power plant on local water supplies (U.S. Government Accountability Office 2012b).
- Perform electric generation risk assessments related to the ability of power plants to continue operation during heat waves and extended droughts. These vulnerabilities should be evaluated at the state level or by the bulk power system operator in consultation with water managers, taking into account all relevant data regarding future water demands and availability. Such information should be weighed in the electricity procurement process.
- Encourage existing power plants to explore alternative cooling technologies and water sources, such as using reclaimed or brackish water, using thermal discharges to desalinate water (Sovacool and Sovacool 2009), or using air cooling systems. Regulations in California have promoted alternative water sources for power plants since 1975.<sup>44</sup>
- Incorporate the costs of alternative cooling technologies, the water sources required to operate them, and anticipated carbon prices in analyses of the economic viability of thermoelectric plants in an increasingly water- and climate-constrained world. The costs of water included in these analyses should be based on local water costs, excluding any subsidies to water supplies.
- Encourage investments in energy efficiency and renewable technologies that require little water.
- Review all federal and state water subsidies; continue to provide subsidies only if they are supported by a thorough assessment of the social and economic impacts of water supply on all sectors, including agricultural, municipal, industrial, and indigenous tribal users of water, as well as the energy sector.

In addition, information and regulation related to the water quality impacts of fuel extraction and wastewater must be strengthened. In particular:

- More information is needed regarding the chemicals present in treated wastewater and fracking fluids. Communities have the right to know about the use of carcinogenic and

---

<sup>44</sup> Since 1975, California has had a formal policy that requires power plant applicants to consider alternative water sources prior to proposing to use freshwater. In 2003, the California Energy Commission reiterated this policy and stated that freshwater use for power plant cooling would only be approved in limited circumstances. Commission staff explicitly encourage developers to consider advanced cooling technologies, including dry cooling and reclaimed water, for power plant cooling needs. Of twenty power plant applications pending before the commission in 2009, only one planned to use freshwater for cooling (U.S. Government Accountability Office 2012b).

toxic substances in close proximity to public water supplies; claims of trade secrets cannot be used to conceal the use of life-threatening substances.

- Regulations regarding the use and storage of such chemicals must be strengthened. If dangerous chemicals cannot be used safely, they should not be used at all. The price of energy should include the cost of producing it in a manner that protects human health and the environment.
- Mine reclamation needs to be held to high standards, restoring or replacing the previously existing ecosystems. All too often, once-pristine forests and valleys have been “reclaimed” with thinly seeded grass atop ruined heaps of rubble, while miles of free-flowing streams have been irretrievably lost. Mountaintop removal only looks profitable because coal companies are not held responsible for its devastating environmental costs.
- Uranium mining, in its heyday, caused long-lasting harm to affected water bodies, and to the health of miners and their communities. If the industry revives, it must be strictly regulated to control the dangers of radioactive contamination. Regulations on uranium mining in Colorado and in Canada provide useful models for new state regulations elsewhere (Fiske 2012).

Such regulations are expensive; there is no doubt that compliance with them will raise the market prices of fossil fuels and uranium. It is commonly argued that we can’t afford such costs, that the need for low-cost energy trumps the desire for environmental protection. This view is mistaken: we are already paying the costs of widespread health and environmental damage, in the intolerable impacts on the fracked, strip-mined, and otherwise harmed communities. At present, however, the costs are borne by the host communities where the fuels are found, while the benefits of cheap energy are enjoyed by consumers everywhere.

The “polluter pays principle”—or, in more academic terms, the basic framework of environmental economics—calls for internalizing the external costs of energy production. If fuel production and use imposes costs on third parties, such as mining communities, those costs should be included in the price of energy. This is not making energy more expensive. Rather, it is admitting how expensive to someone, in health and environmental terms, energy already is—and then asking why anyone other than the energy producers and consumers should pay such costs.

Once the environmental costs of conventional fuels are recognized, it becomes clear that energy efficiency and renewable energy are bargains by comparison. These clean alternatives cause little if any harmful environmental impacts. On a full-cost accounting basis, clean energy would win out as the least-cost solution and solution that harbors the least risk, as our energy system would no longer threaten (or be vulnerable to) the quantity and quality of our water.



## 7. Works Cited

- Abdelouas, Abdesselam. "Uranium Mill Tailings: Geochemistry, Mineralogy, and Environmental Impact." *Elements*, 2006: 335-341.
- Ackerman, Frank, and Elizabeth A. Stanton. *Climate Economics: The State of the Art*. London and New York: Routledge, 2013.
- Administrative Order by Consent - Order No. IV-349*. 1V (Oil and gas Conservation Commission of the State of Colorado, June 22, 2010).
- Ahern, Melissa M., Michael Hendryx, Jamison Conley, Evan Fedorko, Alan Ducatman, and Keith J. Zullig. "The association between mountaintop mining and birth defects among live births in central Appalachia, 1996-2003." *Environmental Research*, 2011: 838-846.
- Alley, W.M., et al. *Progress Toward Establishing a National Assessment of Water Availability and Use*. U.S. Geological Survey Circular 1384, USGS, 2013.
- Andrews, Anthony, et al. *Unconventional Gas Shales: Development, Technology, and Policy Issues*. Washington, DC: Congressional Research Service, 2009.
- Anonymous. "NaturalGas.org." *The Transportation of Natural Gas*. 2011.  
<http://www.naturalgas.org/naturalgas/transport.asp>.
- Appalachian Voices. "North Carolina Coal Ash Pond Ground Water Contamination Analysis." 2009.
- Averyt, K., et al. *Freshwater Use by US Power Plants: Electricity's Thirst for a Precious Resource*. A report of the Energy and Water in a Warming World initiative., Cambridge, MA: Union of Concerned Scientists, 2011.
- Averyt, K., J. Macknick, J. Rogers, N. Madden, J. Fisher, and J. Meldrum. "Water Use for Electricity in the United States: An Analysis of Reported and Calculated Water Use Information for 2008." *Environmental Research Letters*, 2013.
- Bernhard, Emily S., and Margaret A. Palmer. "The environmental costs of mountaintop mining valley fill operations for aquatic ecosystems of the Central Appalachians." *Annals of the New York Academy of Sciences*, 2011: 39-57.
- Bernhardt, Emily S., et al. "How Many Mountains Can We Mine? Assessing the Regional Degradation of Central Appalachian Rivers by Surface Coal Mining." *Environmental Science & Technology*, 2012: 8115-8122.
- Beshears, Erica. "Obstacle to more power: Hot water; River temperature so high that Duke Energy curtails work at 2 plants." *Knight Ridder Tribune Business News*. August 12, 2007.  
[http://www.arizonaenergy.org/News\\_07/News\\_Aug07/Obstacle%20to%20more%20power--%20Hot%20water--%20River%20temperature%20so%20high%20that%20Duke%20Energy%20curtails%20work.htm](http://www.arizonaenergy.org/News_07/News_Aug07/Obstacle%20to%20more%20power--%20Hot%20water--%20River%20temperature%20so%20high%20that%20Duke%20Energy%20curtails%20work.htm) (accessed April 18, 2013).

- Blöschl, Günter, and Alberto Montanari. "Climate change impacts - throwing the dice?" *Hydrological Processes*, 2010: 374-381.
- Branch, Glenn. "Not Smart, But Not ALEC Either." *Desmogblog.com*. February 28, 2013. <http://www.desmogblog.com/2013/02/28/not-smart-not-alec-either> (accessed April 25, 2013).
- Broder, John. "Court Backs EPA Veto of Mining Permit." *New York Times*, April 24, 2013.
- Brugge, Doug, and Rob Goble. "The History of Uranium Mining and the Navajo People." *American Journal of Public Health*, 2002: 1410-1419.
- Brugge, Doug, Jamie L. deLemos, and Cat Bui. "The Sequoyah Corporation Fuels Release and the Church Rock Spill: Unpublicized Nuclear Releases in American Indian Communities." *American Journal of Public Health*, 2007: 1595-1600.
- Bryan, Susan Montoya. "Battle Brewing over Proposed Power Plant." *Albuquerque Journal*, May 11, 2006.
- Burnell, James, Christopher Carroll, and Genevieve Young. *Colorado Miner and Energy Industry Activities 2007*. Boulder, CO: Colorado Geological Survey, Department of Natural Resources, 2008.
- Camp Dresser & McKee, Inc and Harvey Economics. *Colorado's Future Water Supply: State of Colorado 2050 Municipal & Industrial Water Use Projections*. Colorado Water Conservation Board, 2010.
- Caputo, Anton, and Asher Price. "Water Helps Fuel Debate on STP." *My San Antonio*. September 13, 2009. [http://www.mysanantonio.com/news/local\\_news/Water\\_helps\\_fuel\\_debate\\_on\\_the\\_STP.html](http://www.mysanantonio.com/news/local_news/Water_helps_fuel_debate_on_the_STP.html).
- Carter, Nicole. *Energy's Water Demand: Trends, Vulnerabilities, and Management*. Congressional Research Service, 2010.
- Caruso, Doug. "Coal slurry spill threatens Belmont County cree,." *Columbus Dispatch*, October 1, 2010.
- Center for Climate and Energy Solutions. "Carbon Capture and Storage Fact Sheet." *Center for Climate and Energy Solutions*. 2012. <http://www.c2es.org/technology/factsheet/CCS>.
- Chesapeake Energy. *Water Use in Barnett Deep Shale Exploration*. Fact Sheet, Chesapeake Energy, 2012e.
- Chesapeake Energy. *Water Use in Deep Shale Gas Exploration*. Fact Sheet, Chesapeake Energy, 2012a.
- Chesapeake Energy. *Water Use in Eagle Ford Deep Shale Exploration*. Fact Sheet, Chesapeake Energy, 2012d.
- Chesapeake Energy. *Water Use in Haynesville Deep Shale Exploration*. Fact Sheet, Chesapeake Energy, 2012c.

- Chesapeake Energy. *Water Use in Marcellus Deep Shale Exploration*. Fact Sheet, Chesapeake Energy, 2012b.
- Chesapeake Energy. *Water Use in Niobrara Deep Shale Exploration*. Fact Sheet, Chesapeake Energy, 2012f.
- Colbert, Stephen. "The Word - Sink or Swim." *Colbert Nation*. June 4, 2012. <http://www.colbertnation.com/the-colbert-report-videos/414796/june-04-2012/the-word---sink-or-swim> (accessed April 24, 2013).
- Colorado Department of Natural Resources. "Energy Resources - Natural Gas." *Colorado Geological Survey*. July 30, 2012. <http://geosurvey.state.co.us/energy/Natural%20Gas/Pages/NaturalGas.aspx> (accessed April 18, 2013).
- . "Colorado Coal: Energy Security for the Future." *Rock Talk*, Summer 2005.
- Colorado Oil and Gas Conservation Commission. *Oil and Gas Industry Spills and Releases*. Denver: Colorado Department of Natural Resources, 2011.
- Committee on Energy and Commerce. "Chemicals Used in Hydraulic Fracturing." 2011.
- Cooley, Heather, Julian Fulton, and Peter Gleick. *Water for Energy: Future Water Needs for Electricity in the Intermountain West*. Oakland: Pacific Institute, 2011.
- Copeland, Claudia. *Mountaintop Mining: Background on Current Controversies*. Washington, DC: Congressional Research Service, 2012.
- DiGiulio, Dominic C, Richard T Wilkin, Carlyle Miller, and Gregory Oberley. *Investigation of Ground Water Contamination near Pavillion, Wyoming*. Draft, Ada, OK: U.S. Environmental Protection Agency - National Risk Management Research Laboratory, 2011.
- Downing, Bob. "Radioactive Waste from Drilling Hot Topic with Ohio Eco-Groups." *Akron Beacon Journal Online*, May 21, 2013.
- Eastern Research Group. "Preferred and Alternative Methods for Estimating Air Emissions from Oil and Gas Field Production and Processing Operations." In *Emission Inventory Improvement Program: Technical Report Series 2 - Point Sources*, by U.S. Environmental Protection Agency. U.S. Environmental Protection Agency, 1999.
- Elcock, Deborah. "Future U.S. Water Consumption: The Role of Energy Production." *Journal of the American Water Resources Association* 46, no. 3 (2010): 447-460.
- Epstein, Paul R., et al. "Full cost accounting for the life cycle of coal." *Annals of the New York Academy of Sciences*, 2011: 73-98.
- ERCOT. "Long-term System Assessment for the ERCOT Region." Reports to the Legislature on Renewable Energy and the Need for Generation and Transmission Facilities, 2012.
- Esch, Laura, and Michael Hendryx. "Chronic Cardiovascular Disease Mortality in Mountaintop Mining Areas of Central Appalachian States." *Journal of Rural Health*, 2011: 350-357.

- Ferguson, Suzanne. *Utility System Optimisation for LNG & GTL Facilities*. Technical Paper, Foster Wheeler, 2011.
- Fisk, Shannon. "Murray Energy Turns Captina Creek Into Coal Sludge River in Ohio." *NRDC Switchboard*. October 3, 2010.  
[http://switchboard.nrdc.org/blogs/sfisk/murray\\_energy\\_turns\\_captina\\_cr.html](http://switchboard.nrdc.org/blogs/sfisk/murray_energy_turns_captina_cr.html)  
 (accessed April 22, 2013).
- Fiske, William Brice. "Virginia's Moratorium: Is Uranium Mining on the Horizon in the Commonwealth?" *William & Mary Environmental Law and Policy Review*, 2012: 289-317.
- Freyman, Monika, and Ryan Salmon. *Hydraulic Fracturing and Water Stress: Growing Competitive Pressures for Water*. Boston: Ceres, 2013.
- Glass, Alexander, and Orrin Pilkey. "Denying sea-level rise: How 100 centimeters divided the state of North Carolina." *Earth: The Science Behind the Headlines*. April 21, 2013.  
<http://www.earthmagazine.org/article/denying-sea-level-rise-how-100-centimeters-divided-state-north-carolina> (accessed April 24, 2013).
- Gregg, Rachel, Kirsten Feifel, Jessi Kershner, and Jessica Hitt. *The State of Climate Change Adaptation in the Great Lakes Region*. Bainbridge Island: EcoAdapt, 2012.
- Grubert, Emily, and Saya Kitasei. *How Energy Choices Affect Fresh Water Supplies: A Comparison of U.S. Coal and Natural Gas*. Briefing Paper, Washington DC: Worldwatch Institute, 2010.
- H. John Heinz III Center for Science, Economics, and the Environment. *The State of the Nation's Ecosystems: MEasuring the Lands, Waters, and Living Resources of the United States*. New York: Cambridge University Press, 2002.
- Heartland Consumers Power District. "Annual Report." 2008.
- Hendryx, Michael, Evan Fedorko, and Joel Halverson. "Pollution Sources and Mortality Rates Across Rural-Urban Areas in the United States." *Journal of Rural Health*, 2010: 383-391.
- Herzog, Howard, and Dan Golomb. "Carbon Capture and Storage from Fossil Fuel Use." In *Encyclopedia of Energy*, by C.J. Cleveland. New York: Elsevier, 2004.
- Higgins, Thomas E, A Thomas Sandy, and Silas W Givens. "Flue Gas Desulfurization Wastewater Treatment Primer." *Power*, 2009.
- Hopkins, Robert L., Bradley M. Altier, Derek Haselman, Andrea D. Merry, and Jacob J. White. "Exploring the legacy effects of surface coal mining on stream chemistry." *Hydrobiologia*, 2013.
- Hubbard, Burt. "Millions of Gallons Spilled in Colorado over 2.5 Year Period." *The Denver Post*, June 28, 2010.
- Ingraffea, Anthony. "Fluid Migration Mechanism Due to Faulty Well Design and/or Construction: An Overview and Recent Experiences in the Pennsylvania Marcellus Play." 2012.

- Jonsson, B, and N. Jonsson. "A review of the likely effects of climate change on anadromous Atlantic salmon (*Salmo salar*) and brown trout (*Salmo trutta*), with particular reference to water temperature and flow." *Journal of Fish Biology*, 2009: 2381-2447.
- Karvonen, Anssi, Päivi Rintamäki, Jukka Jokela, and E. Tellervo Valtonen. "Increasing water temperature and disease risks in aquatic systems: Climate change increases the risk of some, but not all, diseases." *International Journal for Parasitology*, 2010: 1483-1488.
- Kenny, J.F., N.L. Barber, S.S. Hutson, K.S. Linsey, J.K. Lovelace, and M.A. Maupin. *Estimated use of water in the United States in 2005*. U.S. Geological Survey Circular 1344, Reston, VA: U.S. Geological Survey, 2009.
- Kenward, Alyson. "In Tennessee, Heat Waves Diminish Nuclear Power Output." *Climate Central*. April 10, 2011. <http://www.climatecentral.org/news/in-tennessee-heat-waves-frustrate-nuclear-power> (accessed April 18, 2013).
- Kilpatrick, C. "Drought Fueling Power Concerns: Duke Facing a Problem as WAter Level Drops on Lake Norman." *Charlotte Observer*, November 1, 2007.
- King, Harriet. "Report Says Power Resources Good in NW Through 2013 -- but Watch Those Summers." *Platts Power Markets Week*, September 22, 2008.
- Klett, M., et al. *Power Plant Water Usage and Loss Study*. U.S. Department of Energy National Energy Technology Laboratory, 2007.
- Kopytko, Natalie, and John Perkins. "Climate change, nuclear power, and the adaptation-mitigation dilemma." *Energy Policy*, 2011: 318-333.
- Krupnick, Alan, Hal Gordon, and Sheila Olmstead. "Pathways to Dialogue: What the Experts Say About the Environmental Risks of Shale Gas Development." 2013.
- Lee, Mike, and Edward Klump. "Ohio's \$500 Billion Oil Dream Fades as Utica Turns Gassy." *Bloomberg*, April 15, 2013.
- Lindberg, T. Ty, et al. "Cumulative Impacts of Mountaintop Mining on an Appalachian Watershed." *PNAS*, 2011: 20929-20934.
- Linert, Brenda. "Two Indicted in Ohio Brine Dumping Case." *Shale Play*, March 1, 2013.
- Lofgren, Brent. "A Model for Simulation of the Climate and Hydrology of the Great Lakes Basin." *Journal of Geophysical Research* 109, no. D18, 27 (2004): 2156-2202.
- Lovan, Dylan. "Appeals Court Rejects Coal Permitting Process." *Business Week*, April 23, 2013.
- Lunsford, Kevin, and Jerry Bullin. "Optimiziation of Amine Sweetening Units." *Proceedings of the 1996 AIChE Spring National Meeting*. New York: American Institute of Chemical Engineers, 1996.
- Lustgarten, Abrahm. "Officials in Three States Pin Water Woes on Gas Drilling." *ProPublica*, 2009.

- Lutz, Brian, Aurana Lewis, and Martin Doyle. "Generation, Transport, and Disposal of Wastewater Associated with Marcellus Shale Gas Development." *Water Resources Research*, 2013: 647-656.
- Macknick, Jordan, Robin Newmark, Garvin Heath, and KC Hallett. *A Review of Operational Water Consumption and Withdrawal Factors for Electricity Generating Technologies*. Golden, CO: National Renewable Energy Laboratory, 2011.
- Mantua, Nathan, Ingrid Tohver, and Alan Hamlet. "Climate change impacts on streamflow extremes and summertime stream temperature and their possible consequences for freshwater salmon habitat in Washington State." *Climatic Change*, 2010: 187-223.
- Maulbetsch, John, and Michael DiFilippo. *Cost and Value of Water Use at Combined-Cycle Power Plants*. PIER Final Project Report, California Energy Commission, 2006.
- McFeeley, Matthew. "State Hydraulic Fracturing Disclosure Rules and Enforcement: A Comparison." 2012.
- Mielke, Erik, Laura Diaz Anadon, and Venkatesh Narayanamurti. *Water Consumption of Energy Resource Extraction, Processing, and Conversion*. Cambridge, MA: Energy Technology Innovation Policy Research Group, 2010.
- Mishra, Shruti K., Frederick J. Hitzhusen, Brent L. Sohngen, and Jean-Michel Guldmann. "Costs of abandoned coal mine reclamation and associated recreation benefits in Ohio." *Journal of Environmental Management*, 2012: 52-58.
- Mittal, Anu. *Energy Development and Water Use: Impacts of Potential Oil Shale Development on Water Resources*. Testimony before the Subcommittee on Energy and Mineral Resources, Committee on Natural Resources, House of Representatives, Washington DC: U.S. Government Accountability Office, 2011.
- Moulton, Sean, and Sofia Plagakis. *The Right to Know, the Responsibility to Protect*. OMB Watch, 2012.
- National Academy of Sciences. *Hidden Costs of Energy: Unpriced Consequences of Energy Production and Use*. Washington, DC: The National Academies Press, 2010.
- National Conference of State Legislatures. *Assessing the Costs of Climate Change - Ohio*. University of Maryland's Center for Integrative Environmental Research, 2008.
- National Energy Technology Laboratory. "Advantages of Gasification - Environmental Benefits." *National Energy Technology Laboratory*. 2013.  
<http://www.netl.doe.gov/technologies/coalpower/gasification/gasifipedia/7-advantages/index.html>.
- National Energy Technology Laboratory. *Cost and Performance Baseline for Fossil Energy Plants: Volume 1: Bituminous Coal and Natural Gas to Electricity, Revision 2*. U.S. Department of Energy, 2010.
- National Energy Technology Laboratory. *Power Plant Water Usage and Loss Study*. Revision of August 2005 report, U.S. Department of Energy, 2007.

- National Energy Technology Laboratory. *Water Requirements for Existing and Emerging Thermoelectric Plant Technologies*. April 2009 Revision of August 2008 Report. DOE/NETL-402/080108, U.S. Department of Energy, 2009.
- National Research Council. *Uranium Mining in Virginia: Scientific, Technical, Environmental, Human Health and Safety, and Regulatory Aspects of Uranium Mining and Processing in Virginia*. Washington, D. C.: National Academies Press, 2012.
- NERC. *Winter Reliability Assessment: 2011/2012*. Atlanta: North American Electric Reliability Corporation, 2011.
- Ngai, Ka Lai Christine, Brian J Shuter, Donald A Jackson, and Sudeep Chandra. "Projecting impacts of climate change on surface water temperatures of a large subalpine lake: Lake Tahoe, USA." *Climatic Change*, 2013.
- Nuclear Energy Agency. *Uranium 2011: Resources, Production and Demand*. Paris: Organization for Economic Co-operation and Development, 2012.
- O'Donoghue, Amy Joi. "Lawsuits challenge water rights granted for nuclear power plant." *Deseret News*, March 28, 2012.
- . "Nuclear Power Plant in Utah? First Step is Securing Water Rights." *Deseret News*, October 30, 2011.
- O'Grady, Eileen, and Marguerita Choy. "Drought Adds to 2012 Texas Power Supply Worry." *Reuters*, October 18, 2011.
- Ohio Department of Natural Resources. "Shale Well Drilling & Permitting - 2011 Utica Shale Gas Production." *Ohio Division of Oil and Gas Resources*. 2013. <http://oilandgas.ohiodnr.gov/industry/shale-well-drilling#UTICA> (accessed April 25, 2013).
- Ohio Department of Transportation. "Maritime and Freight Program." *Ohio Department of Transportation Division of Planning*. 2013. [http://www.dot.state.oh.us/Divisions/Planning/SPR/StatewidePlanning/Pages/Maritime\\_Freight\\_Program.aspx](http://www.dot.state.oh.us/Divisions/Planning/SPR/StatewidePlanning/Pages/Maritime_Freight_Program.aspx) (accessed April 25, 2013).
- Ohio EPA. *Biological and Water Quality Study of the McMahan Creek Watershed and Selected Ohio River Tributaries, 2009*. Columbus, OH: Ohio EPA, 2010.
- Ohio EPA. *Biological and Water Quality Study of the Sunfish Creek Watershed and Selected Ohio River Tributaries, 2009*. Columbus, OH: Ohio EPA, 2010.
- Osborn, Stephen, Avner Vengosh, Nathaniel Warner, and Robert Jackson. "Methane Contamination of Drinking Water Accompanying Gas-Well Drilling and Hydraulic Fracturing." *Proceedings of the National Academies of Science* 108, no. 20 (2011): 8172-8176.
- Panikkar, Bindu, and Doug Brugge. "The Ethical Issues in Uranium Mining Research in the Navajo Nation." *Accountability in Research*, 2007: 121-153.
- Penn State Extension. "How Much Natural Gas Can the Marcellus Shale Produce?" *Penn State College of Agricultural Sciences*. February 5, 2012.

<http://extension.psu.edu/natural-resources/natural-gas/news/2012/how-much-natural-gas-can-the-marcellus-shale-produce> (accessed April 25, 2013).

- Pickrell, Emily. "Drought Puts Drain on Water Supplies for Power Plants." *Houston Chronicle*, February 6, 2013.
- Poff, N. LeRoy, Matthew I Pyne, Brian P Bledsoe, Christopher C Cuhacyan, and Daren M Carlisle. "Developing linkages between species traits and multiscaled environmental variation to explore vulnerability of stream benthic communities to climate change." *Journal of the North American Benthological Society*, 2010: 1441-1458.
- Powers, Mary. "Drought Drives TVA to Buy More Power, and "It May Feel Like It is Over, but It Isn't"." *Platts Power Markets Week*, August 11, 2008.
- ProChemTech International, Inc. "Marcellus Gas Well Hydrofracture Wastewater Disposal by Recycle Treatment Process." *ProChemTech International*. 2009.  
[http://www.prochemtech.com/Literature/TAB/PDF\\_TAB\\_Marcellus\\_Hydrofracture\\_Disposal\\_by\\_Recycle\\_1009.pdf](http://www.prochemtech.com/Literature/TAB/PDF_TAB_Marcellus_Hydrofracture_Disposal_by_Recycle_1009.pdf) (accessed April 8, 2013).
- Quinlan, Paul. "Lake Mead's Water Level Plunges as 11-Year Drought Lingers." *The New York Times*, August 13, 2010.
- Ray, Andrea, et al. *Climate Change in Colorado: A Synthesis to Support Water Resources Management and Adaptation*. Feature Article from the Intermountain West Climate Summary, Boulder, CO: University of Colorado at Boulder, 2008.
- Reisner, M. *Cadillac Desert: The American West and its Disappearing Water*. New York: Viking-Penguin, 1986.
- Rozell, Daniel, and Sheldon Reaven. "Water Pollution Risks Associated with Natural Gas Extraction from the Marcellus Shale." *Risk Analysis*, 2012: 1382-1393.
- Ruhl, Laura, Avner Vengosh, Gary Dwyer, Heileen Hsu-Kim, and Amrika Deonarine. "Environmental Impact of the Coal Ash Spill in Kingston, Tennessee: An 18-Month Survey." *Environmental Science and Technology* 44, no. 24 (2010): 9272-9278.
- Sempra U.S. Gas & Power. *Natural Gas Pipeline in Operation*. 2013.  
<http://www.semprausgp.com/energy-solutions/natural-gas-rockies-express-pipeline.html> (accessed April 22, 2013).
- Smyth, Julie Carr. "Ohio Seeks New Tests, Reports on Drilling Waste." *Bloomberg Businessweek*, February 12, 2013.
- Sovacool, Benjamin, and Kelly Sovacool. "Identifying Future Electricity-Water Tradeoffs in the United States." *Energy Policy*, 2009: 2763-2773.
- Subcommittee on Ground Water of the Advisory Committee on Water Information. *A National Framework for Ground-Water Monitoring in the United States*. Advisory Committee on Water Information, 2009.
- Susquehanna River Basin Commission. "Susquehanna River Basin Commission." *64 Water Withdrawals for Natural Gas Drilling and Other Uses Suspended to Protect Streams*.



- July 16, 2012.  
<http://www.srbc.net/newsroom/NewsRelease.aspx?NewsReleaseID=90>.
- Tennessee Valley Authority. "Form 10-K (Annual Report)." 2007.
- The Denver Post. "Benzene from Gas Plant Leak Polluting Groundwater near Parachute Creek." *The Denver Post*, March 28, 2013.
- U.S. Bureau of Reclamation. *Colorado River Basin Water Supply and Demand Study*. U.S. Department of the Interior, 2012.
- U.S. Census Bureau. "2012 National Population Projections: Summary Tables." 2012.  
<http://www.census.gov/population/projections/files/summary/NP2012-T1.xls>  
(accessed 02 26, 2013).
- U.S. Census Bureau. *State interim population projections by age and sex: 2004-2030*. 2005.
- U.S. Department of Energy. *Energy Demands on Water Resources*. Report to Congress, U.S. Department of Energy, 2006.
- U.S. Energy Information Administration. *Annual Energy Outlook 2012*. Washington, DC: U.S. Department of Energy, 2012.
- U.S. Energy Information Administration. *Annual Energy Review*. Washington, DC: U.S. Department of Energy, 2012e.
- . *Colorado Profile Analysis*. October 2009. <http://www.eia.gov/state/analysis.cfm?sid=CO>.
- U.S. Energy Information Administration. *Electric Power Annual 2011*. U.S. Department of Energy, 2013c.
- U.S. Energy Information Administration. *Electric Power Monthly*. Table 1.1. Net Generation by Energy Source: Total (All Sectors) 2002-December 2012, EIA, 2013b.
- U.S. Energy Information Administration. *Electricity - Detailed State Data*. October 2, 2012b.
- . "Electricity Data Browser Custom Report: Net Generation for Colorado in 2012." *U.S. Energy Information Administration*. 2013e.  
<http://www.eia.gov/electricity/data/browser/#/topic/0?agg=2,0,1&fuel=vtt8&geo=0000000000g&sec=008&linechart=ELEC.GEN.WND-CO-98.A~ELEC.GEN.SUN-CO-98.A~ELEC.GEN.GEO-CO-98.A~ELEC.GEN.BIO-CO-98.A~ELEC.GEN.COW-CO-98.A~ELEC.GEN.PEL-CO-98.A~ELEC.GEN.PC-CO-98.A~E> (accessed April 17, 2013).
- . "Natural Gas Annual Respondent Query System." *U.E. Energy Information Administration*. September 2012d. [http://www.eia.gov/cfapps/ngqs/ngqs.cfm?f\\_report=RP7](http://www.eia.gov/cfapps/ngqs/ngqs.cfm?f_report=RP7) (accessed April 11, 2013).
- . "State Profile and Energy Estimates; Rankings, 2011." *U.S. Energy Information Administration*. 2013d. <http://www.eia.gov/state/search/#?3=25&a=true>.
- . "Table 9.3. Quantity and Net Summer Capacity of Operable Cooling Systems, by Energy Source and Cooling System Type (2007-2011)." *Electric Power Annual*. US Energy Information Administration, January 30, 2013.

- "Coal Plants Without Scrubbers Account for a Majority of U.S. SO<sub>2</sub> Emissions." *Today in Energy*, December 21, 2011.
- "Working Natural Gas Storage Capacity Grows 3% Year-Over-Year." *Today in Energy*, September 12, 2012c.
- "U.S. Energy Information Administration." *Colorado Natural Gas Marketed Production - Annual*. March 29, 2013f. <http://tonto.eia.gov/dnav/ng/hist/n9050co2a.htm>.
- U.S. Environmental Protection Agency. "Coal Combustion Residues (CCR) - Surface Impoundments with High Hazard Potential Ratings." *U.S. Environmental Protection Agency*. April 2012. <http://www.epa.gov/osw/nonhaz/industrial/special/fossil/ccrs-fs/index.htm> (accessed April 24, 2013).
- U.S. Environmental Protection Agency. "Environmental and Economic Benefits Analysis for Proposed Section 316(b) Existing Facilities Rule, EPA 821-R-11-002." Washington, DC, 2011.
- U.S. Environmental Protection Agency. *Human and Ecological Risk Assessment of Coal Combustion Wastes: Draft*. Washington, DC: U.S. Environmental Protection Agency, 2007.
- "EPA Science on Mountaintop Mining." *Science Matters Newsletter*, August 2010.
- U.S. Environmental Protection Agency. "Steam Electric Power Generating Point Source Category: Final Detailed Study Report." October 2009.
- "The process of hydraulic fracturing." *United States Environmental Protection Agency*. February 7, 2013. <http://www2.epa.gov/hydraulicfracturing/process-hydraulic-fracturing> (accessed March 18, 2013).
- U.S. EPA. "EPA Newsroom." *EPA Proposes to Reduce Toxic Pollutants Discharged into Waterways by Power Plants*. 2013. <http://yosemite.epa.gov/opa/admpress.nsf/0/8F5EF6C6955F6D2085257B52006DD32F> (accessed April 24, 2013).
- U.S. Geological Survey. *Ground-Water Depletion Across the Nation*. Fact Sheet 103-03, USGS, 2003.
- U.S. Geological Survey. *Radioactive Elements in Coal and Fly Ash: Abundance, Forms, and Environmental Significance*. USGS Fact Sheet FS-163-97, U.S. Geological Survey, 1997.
- U.S. Global Change Research Program. *Global Climate Change Impacts in the United States*. Edited by Thomas Karl, Jerry Melillo and Thomas Peterson. New York: Cambridge University Press, 2009.
- U.S. Government Accountability Office. *Energy-Water Nexus: A Better and Coordinated Understanding of Water Resources Could Help Mitigate the Impacts of Potential Oil Shale Development*. Report to Congressional Requesters, Washington, DC: U.S. Government Accountability Office, 2010.

- U.S. Government Accountability Office. *Energy-Water Nexus: Coordinated Federal Approach Needed to Better Manage Energy and Water Tradeoffs*. Report to the Ranking Member, Committee on Science, Space, and Technology, House of Representatives, Washington, DC: United States Government Accountability Office, 2012b.
- U.S. Government Accountability Office. "Improvements to Federal Water Use Data Would Increase Understanding of Trends in Power Plant Water Use." *Energy-Water Nexus Report to the Chairman, Committee on Science and Technology, House of Representatives, Washington, DC, 2009*.
- U.S. Government Accountability Office. *Information on the Quantity, Quality, and Management of Water Produced during Oil and Gas Production*. Energy-Water Nexus Report to the Ranking Member, Committee on Science, Space, and Technology, House of Representatives, Washington, DC: U.S. Government Accountability Office, 2012.
- URS Corporation. *Energy Development Water Needs Assessment (Phase 1 Report)*. Glenwood Springs, CO: Colorado, Yampa, and White River Basin Roundtables Energy Subcommittee, 2008.
- Vidic, R.D., S.L. Brantley, J.M. Vandenbossche, D. Yoxtheimer, and J.D. Abad. "Impact of Shale Gas Development on Regional Water Quality." *Science* 340 (2013).
- Wan, Rongrong, Desheng Liu, Darla K. Munroe, and Shanshan Cai. "Modelling potential hydrological impact of abandoned underground mines in the Monday Creek Watershed, Ohio." *Hydrological Processes*, 2012.
- Waughray, Dominic, ed. *Water Security: The Water-Food-Energy-Climate-Nexus*. Washington, DC: Island Press, 2011.
- Webb, Dennis. "Benzene in Creek "Of Great Concern"." *The Daily Sentinel*, April 19, 2013.
- Weiss, Mitch. "Drought Could Force Nuke-Plant Shutdowns." *USA Today*, January 25, 2008.
- Wenger, Seth J, et al. "Flow regime, temperature, and biotic interactions drive differential declines of trout species under climate change." *Proceedings of the National Academy of Sciences*, 2011: 14175-14180.
- Whitehead, P.G., R. L. Wilby, R. W. Battarbee, M. Kernan, and A.J. Wade. "A review of the potential impacts of climate change on surface water quality." *Hydrological Sciences Journal*, 2009: 101-123.
- Wilbanks, T.J., V. Bhatt, D.E. Bilello, S.R. Bull, J.Ekmann, W.C. Horak, Y.J. Huang, M.D. Levine, M.J. Sale, D.K. Schmalzer, and M.J. Scott. *Effects of Climate Change on Energy Production and Use in the United States*. U.S. Climate Change Science Program, Synthesis and Assessment Product 4.5, Washington, DC: U.S. Department of Energy, 2008.
- Wilson, Wendy, Travis Leipzig, and Bevan Griffiths-Sattenspiel. *Burning Our Rivers*. Portland: River Network, 2012.

WVIZ/PBS ideastream. "Radioactive Drilling Waste Shipped to Landfills Raises Concerns." *ideastream*. April 2, 2013. <http://www.ideastream.org/news/feature/52913>.

Zah, Erny. "Desert Rock Water Agreement Passes Navajo National Committee." *The Farmington Daily Times*, February 2, 2006.

Zullig, Keith J., and Michael Hendryx. "Health-Related Quality of Life Among Central Appalachian Residents in Mountaintop Mining Counties." *American Journal of Public Health*, 2011: 848-853.

## 8. Appendix

### A. Water Consumption for Carbon Capture

Water is used in carbon capture for chemical and physical processes, as well as to produce additional energy to power the capture process (also called “parasitic” load), which reduces the net exported power of the facility.

Carbon capture processes can generally be categorized in three categories (Herzog and Golomb 2004):

1. Flue gas separation
2. Oxy-fuel combustion in power-plants
3. Pre-combustion separation

Each of these capture technologies impose an energy penalty, requiring energy to operate. This means that the power plant has to combust more fuel to deliver the same amount of electricity to the grid, which in turn implies that the water used for steam and cooling per unit of delivered electricity increases.

Water is used in many of the stages of the capture process as well. Flue gas separation uses a chemical absorption method where CO<sub>2</sub> is absorbed into a liquid solvent, and then the solvent is passed through a regenerator unit where the CO<sub>2</sub> is stripped from the solvent using steam. The water vapor is then condensed, leaving the highly concentrated CO<sub>2</sub> stream that is then compressed for storage, and the solvent is cooled and recycled (Herzog and Golomb 2004). An example of this process, the Econamine process, is shown in Figure 20.

Figure 20. Econamine process for CO<sub>2</sub> removal.

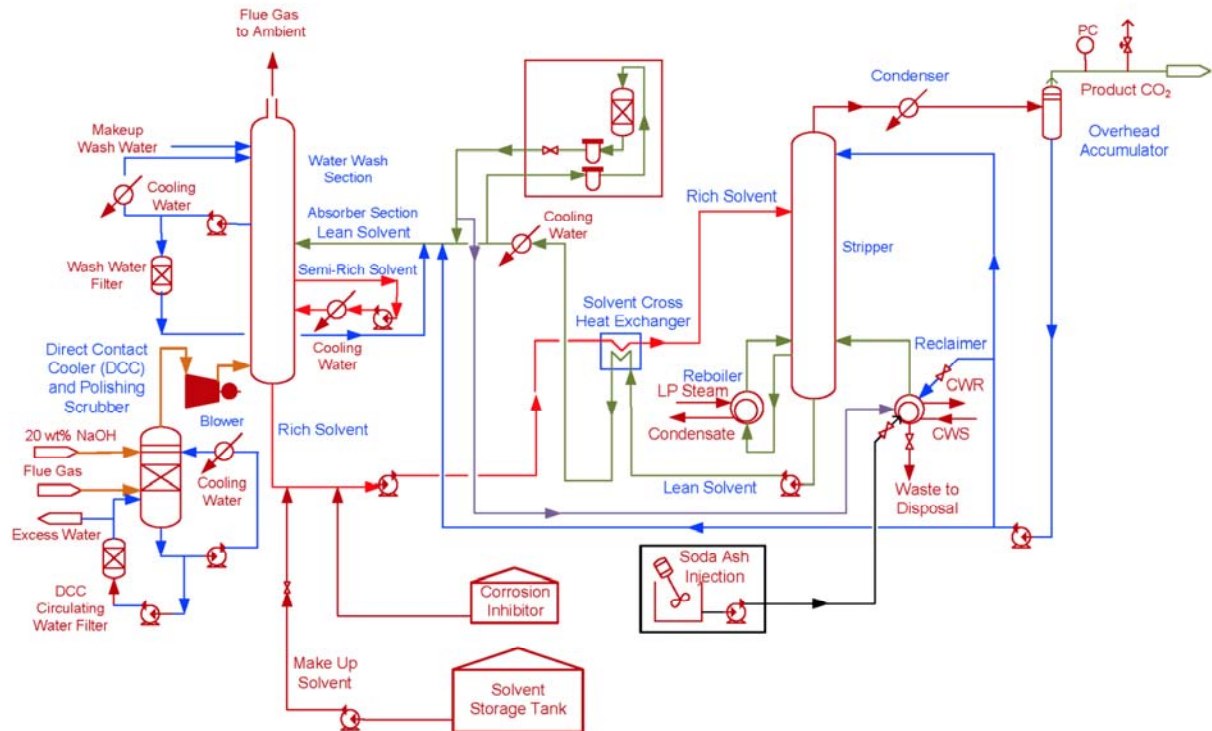

Source: National Energy Technology Laboratory (2010)

Oxy-fuel combustion involves combusting the fuel in pure or enriched oxygen, which produces flue gases containing primarily CO<sub>2</sub> and water. The water vapor is then condensed, while the CO<sub>2</sub> is compressed and piped to a storage site. However, the separation of nitrogen from the air consumes large amounts of energy (approximately 15 percent of a power plant's output) (Herzog and Golomb 2004).

Pre-combustion capture utilizes separation methods such as pressure-swing absorption in solvents such as methanol or polyethylene glycol. The fuel is then gasified into a synthesis gas of CO and H<sub>2</sub>, and the CO is reacted with water (in a water-gas-shift reactor) to produce CO<sub>2</sub> that is later captured, while the H<sub>2</sub> is used to turn the turbine for electricity production (Herzog and Golomb 2004).